

Grove GMK7450

Product Guide



 450 t

 60 m

 12 - 79 m

 136 m

All-Terrain Crane • AT-Kran
Grue Automotrice Routière
Grúa Todo Terreno Rapida • Gru Fuoristrada Veloci
Вездеходный подъемный кран

Contents • Inhalt • Contenu • Contenido Contenuto • Содержание

Specification	3
Technische Daten	4
Caractéristiques techniques	5
Características	6
Caratteristiche	7
Технические характеристики	8
Data • Daten • Caractéristiques • Datos • Dati • Данные	9
Dimensions • Abmessungen • Encombrement • Dimensiones • Dimensioni • Размеры	10
Luffing jib • Wippspitzenausleger • Volée variable • Plumín de angulación variable	
Jib a volata variable • Маневровый гусек	11
Aerial rigging of luffing jib • Rüsten der Wippspitze ohne Bodenkontakt • Montage aérien de la flèche relevable • Reglaje aéreo del plumín angulable • Manovra aerea del braccio inclinabile • Подвесная сборка маховой стрелы	13
Counterweight • Gegengewicht • Contrepoids • Contrapesos • Contrappesi • Противовес	15
Load charts • Traglasten • Capacités de levage • Capacidades • Capacità • Таблицы грузоподъемности	
Notes • Hinweise • Notes • Notas • Note • Примечания	16
Working Range • Arbeitsbereiche • Diagramme de levage • Gama de trabajo	
Area di lavoro • Грузовысотные характеристики	17
Telescopic Boom • Teleskopausleger • Flèche principale • Pluma telescópica	
Braccio telescopico • Телескопическая стрела	18
Telescopic Boom • Teleskopausleger • Flèche principale • Pluma telescópica	
Braccio telescopico • Телескопическая стрела (Mega-Wing lift)	22
Lattice extension • Auslegerverlängerung • Extension treillis • Plumín fijo • Jib • Стрела крана	25
Luffing jib • Wippspitzenausleger • Volée variable • Plumín de angulación variable	
Jib a volata variable • Маневровый гусек	28
Luffing jib • Wippspitzenausleger • Volée variable • Plumín de angulación variable	
Jib a volata variable • Маневровый гусек (Mega-Wing lift)	39
Symbols • Symbolerklärung • Glossaire des symboles • Glosario de símbolos • Glossario dei simboli • Символы	51



Manitowoc Crane Care is the Maniowoc's unparalleled product support organisation. Maniowoc Crane Care combines all aspects of parts, service, technical documentation, technical support and training into one organisation. The program includes all of the Maniowoc's brands, which include, Potain, Grove, Maniowoc and National Crane.

For the care of your crane and the prosperity of your business, Maniowoc Crane Care is your single source for customer support. Wherever, whenever, whatever – we're there.

Maniowoc Crane Care vereint alle Serviceleistungen von Maniowoc im Produktsupport vor und nach dem Verkauf: Ersatzteile, Service, technische Dokumentation, technischer Support und Schulung, alles unter einem Dach. Dieser Service erstreckt sich auf alle Marken von Maniowoc: Potain, Grove, Maniowoc und National Crane.

Damit Ihr Kran leistungsfähig bleibt und Ihr Erfolg gesichert ist, bietet Ihnen Maniowoc Crane Care einen umfassenden Support aus einer Hand. Zu jeder Zeit, an jedem Ort, für jeden Fall – wir sind für Sie da.

Organisation hors pair dédiée au support technique des produits de Maniowoc, Maniowoc Crane Care réunit au sein d'une même entité tous les aspects du service : pièces de rechange, service après-vente, publication technique, assistance technique et formation. Ce programme s'adresse à toutes les marques de Maniowoc : Potain, Grove, Maniowoc et National Crane.

Pour assurer l'entretien de vos grues et la prospérité de votre entreprise, Maniowoc Crane Care constitue votre unique interlocuteur du service à la clientèle. Où que vous soyez, quel que soit votre besoin, vous pouvez toujours compter sur nous !

Maniowoc Crane Care, es la organización post-venta y soporte técnico de Maniowoc. Maniowoc Crane Care combina todos los aspectos de piezas de repuesto, servicio, documentación técnica, apoyo técnico y formación en un único lugar. El programa también incluye todas las ramas Maniowoc que engloba Potain, Grove, Maniowoc y National Crane.

Para el cuidado de su grúa y la prosperidad de su negocio, Maniowoc Crane Care, es la forma más sencilla de ayudarlo. Donde sea y cuando sea, nosotros estamos allí.

Maniowoc Crane Care è l'ineguagliabile organizzazione di supporto di Maniowoc. Maniowoc Crane Care gestisce tutte le attività legate a pezzi di ricambio, documentazione tecnica, assistenza tecnica e formazione riunite in un unico punto di riferimento. Questo servizio è attivo per tutti i marchi di Maniowoc e precisamente Potain, Grove, Maniowoc e National Crane.

Per l'assistenza delle Vostre gru e per la redditività dei Vostri investimenti, Maniowoc Crane Care è l'insostituibile Vostra risorsa. In ogni posto, tutte le volte, per qualsiasi necessità – noi ci siamo

Maniowoc Crane Care - это не имеющая аналогов организация, входящая в Maniowoc и осуществляющая техническую поддержку продукции. Maniowoc Crane Care занимается всеми аспектами, связанными с запасными частями, услугами, технической документацией, технической поддержкой и обучением. Программа включает все торговые марки Maniowoc, в том числе, Potain, Grove, Maniowoc и National Crane.

Maniowoc Crane Care является единой точкой контактов для всех клиентов компании, где они могут получить полное обслуживание для используемых ими кранов, что, в свою очередь, обеспечит процветание их бизнеса. Мы всегда там и в тот момент, где и когда мы необходимы.

Superstructure



Boom

16,0 m to 60,0 m five section TWIN-LOCK™ boom.
Maximum tip height 63,0 m.



Boom elevation

2 cylinder with safety valve, boom angle from -1,2° to +82°.



Load moment and independent anti-two block system

Graphic display load moment and independent anti-two block system with audio-visual warning and control lever lock-out. These systems provide electronic display of boom angle, length, radius, tip height, relative load moment, maximum permissible load, load indication and warning of impending two-block condition with lock-out hoist function.



Cab

Aluminium, tiltable (approx. 20°), full vision, safety glass, adjustable operator's seat with hydraulic suspension, engine independent diesel cab heater incl. 24h timer and air conditioning. Armrest-integrated crane controls. Ergonomically arranged instrumentation and crane operating controls. Cab stowed over rear for road travel.



Slewing

3 slewing gears with axial piston motors, planetary gear, automatic brake with foot operated release switch for free slew.



Counterweight

120 t, consisting of 20 t base section and 10 t sections. Hydraulic removal system.



Engine

Mercedes-Benz OM906LA, diesel, 6 cylinders, water cooled, turbocharged, 205 kW (279 HP) at 1800 rpm. (80/1269 EWG - fan rigid). Max. torque: 1100 Nm at 1200 rpm. Fuel tank capacity: 300 l.
Engine emission: EUROMOT / EPA / CARB (non road).



Hydraulic system

5 separate circuits, 3 axial piston variable displacement pumps with electronic power limiting control, 1 axial piston variable displacement pump for slewing and 1 fixed displacement pump for auxiliary gears. Thermostatically controlled oil cooler.
Tank capacity: 1570 l.



Control system

ECOS electronic control of all crane movements using electrical control levers with automatic reset to zero. Integrated with the LMI and engine management system by CAN-BUS.



Hoist

Axial piston variable displacement motor with planetary gear and brake. Drum rotation indicator. Hoist camera.



Electrical system

Three-phase alternator 28 V/100 A, 2 batteries 12 V/170 Ah.

* Optional equipment

- Mega-Wing-Lift.
- Additional 40 t counterweight to be used with Mega-Wing-Lift (total counterweight 160t).
- Heavy duty jib, 4/7,5 m.
- Lattice extension, 12 - 70 m, in sections of 6 m. 12 - 42 m offsets 3°, 46 - 70 m offsets 3°, 25°.
- Luffing jib, 25 - 79 m, in sections of 6 m.
- Auxiliary hoist.
- Boom removal kit.

Carrier



Chassis

Special 7-axle chassis, all-welded torsion-resistant box type construction in high strength steel.



Outriggers

4 double hydraulically telescoping beams with vertical cylinders and outrigger pads. Independent horizontal and vertical movement control on each side of the carrier. Removable rear outrigger box. Electronic level indicator with automatic levelling system.



Engine

Mercedes-Benz OM502LA, diesel, 8 cylinders, water cooled, turbocharged, 420 kW (571 HP) at 1800 rpm (80/1269 EWG - fan loose). Max. torque: 2700 Nm at 1300 rpm. Fuel tank capacity: 500 l.
Engine emission: EUROMOT / EPA / CARB (non road).



Transmission

Allison automatic 4800 SP, 7 forward and 1 reverse speed. Transverse differential locks. Transfer case with 2 speeds and inter-axle differential lock.



Drive/Steer

14 x 6 x 14.



Axle lines

7 axle lines. 1, 4 and 5 are driven steering axle lines, the 2nd, 3rd, 6th and 7th are steering axle lines.



Suspension

MEGATRAK®. All wheels with independent hydropneumatic suspension and hydraulic lockout. Longitudinal and transverse level control with automatic on-highway levelling system. Range +170 mm/-130 mm.



Tyres

14 tyres, 14.00 R25.



Steering

Dual circuit, hydraulic power assisted steering with emergency steering pump. Axle lines 1, 2, 3, 6 and 7 steer on highway. Separate steering of the 4th, 5th, 6th and 7th axle line for all wheel steering and crabbing.



Brakes

Service brake: pneumatic dual circuit, acting on all wheels, air dryer. Permanent brake: exhaust brake with constant throttle brake and hydraulic transmission retarder. Parking brake: pneumatically operated spring-loaded brake acting on axle lines 2, 4, 5, 6 and 7.



Cab

Aluminium, 2-man-design, safety glass, driver and passenger seat with hydraulic suspension, engine-dependent hot water heater and air conditioning. Complete instrumentation and driving controls.



Electrical system

Three-phase alternator 28 V/100A, 2 batteries 12 V/170 Ah. Lighting system and signals 24 V.

* Optional equipment

- 14 x 8 x 14.
- 14 tyres, 16.00 R25 (vehicle width 3,00 m).
- 14 tyres, 20.5 R25 (vehicle width 3,10 m).
- Folding bunk bed in carrier cab.
- Engine-independent hot water heater, with engine pre-heater.
- Secondary transmission oil cooler.
- Engine shutdown valves (for both engines).

*Further optional equipment upon request.

Kranoberwagen



Teleskopausleger

Von 16,0 m bis 60,0 m ausfahrbarer, fünfteiliger, TWIN-LOCK™ Ausleger. Maximale Rollenhöhe 63,0 m.



Wippwerk

2 Zylinder mit Sicherheits-Rückschlagventil. Auslegerstellwinkel -1,2° bis +82°.



Lastmomentbegrenzer und unabhängiges Hubendechalter System

Grafische Darstellung Lastmomentbegrenzer mit hör- und sichtbarer Vorwarnung sowie automatischer Abschaltung, Digitalanzeige für tatsächliche und zulässige Belastung, Ausladung und diverse Zustände. Unabhängiges Hubendechalter System mit Abschaltfunktion.



Krankabine

Aluminium-Kabine, ca. 20° kippbar, Vollsicht, Sicherheitsglas, verstellbarer Fahrersitz mit hydraulischer Dämpfung, In Armlehnen integrierte Kransteuereinrichtung. Ergonomisch angeordnete Steuer- und Kontrolleinrichtungen. Motorunabhängige Dieselluftheizung inkl. 24h-Zeitschaltuhr und Klimaanlage. Bei Straßenfahrt wird die Kabine zum Heck geschwenkt.



Drehwerk

3 Drehwerke mit Axialkolbenmotoren, Planetengetriebe, automatische Bremse, Freischaltung über Fußtaster.



Gegengewicht

120 t, bestehend aus einer 20t Basisplatte und weiteren 10t - Platten. Hydraulisches Rüstsystem.



Motor

Mercedes-Benz OM906LA, 6 Zylinder Diesel, wassergekühlt mit Abgasturbolader, 205 kW (279 PS) bei 1800 min⁻¹ (80/1269/EWG Ventilator starr), max. Drehmoment 1100 Nm bei 1200 min⁻¹. Kraftstoffbehälter: 300 l. Motoremission: EUROMOT / EPA / CARB (non road).



Hydrauliksystem

5 getrennte Kreisläufe, 3 Axialkolben-Vestellpumpen mit elektronischer Grenzlastregelung, 1 Axialkolben-Vestellpumpen für das Drehwerk und 1 Konstantpumpe für Nebentriebwerke. Thermostatisch gesteuerter Ölkühler. Tankvolumen: 1570 l Hydrauliköl.



Steuerung

ECOS elektronische Steuerung aller Bewegungen mit elektrischen Kreuzsteuerhebeln mit automatischer Nullstellung, verbunden mit der LMB und dem Motormanagement System über den CAN-BUS.



Hubwerk

Axialkolben-Vestellmotor mit Planetengetriebe und Bremse. Hubwerksdrehmelder. Hubwerkskamera.



Elektrische Anlage

Drehstromlichtmaschine 28 V/100 A, 2 Batterien 12 V/170 Ah.

* Zusatzausrüstung

- Mega-Wing-Lift.
- Zusatzgegengewicht 40 t für Mega-Wing-Lift Betrieb (Gesamtgegengewicht 160t).
- Schwerlastspitze, 4/7,5 m.
- Auslegerverlängerung, Gitterkonstruktion 12 - 70 m, in 6 m Abstufungen, 12 - 42 m 3° abwinkelbar, 46 - 70 m 3° und 25° abwinkelbar.
- Wippspitzenausleger, Gitterkonstruktion 25 - 79 m, in 6 m Abstufungen.
- Hilfshebwerk.
- Auslegerdemontage-Set.

Kranunterwagen



Rahmen

7-Achs-Spezialfahrzeug, geschweißte, torsionssteife Kastenkonstruktion aus hochfestem Feinkornstahl.



Abstützung

4 hydraulisch doppelt teleskopierbare Schiebeträgen mit Abstützylindern und Abstützplatten, beidseitig vom Unterwagen aus einzeln horizontal und vertikal steuerbar. Demontierbarer Stützkasten hinten. Elektronische Niveauanzeige mit automatischer Nivellierung.



Motor

Mercedes-Benz OM502LA, 8 Zylinder Diesel, wassergekühlt mit Abgasturbolader, 420 kW (571 PS) bei 1800 min⁻¹ (80/1269/EWG Ventilator lose), max. Drehmoment 2700 Nm bei 1300 min⁻¹. Kraftstoffbehälter: 500 l. Motoremission: EUROMOT / EPA / CARB (non road).



Getriebe

Allison Getriebeautomat 4800 SP, 7 Gänge vorwärts und 1 rückwärts. Querdifferentialsperren. Verteilergetriebe mit 2 Stufen und Längsdifferentialsperre.



Antrieb/Lenkung

14 x 6 x 14.



Achslinien

7 Achslinien, Achsline 1, 4 und 5 gelenkt und angetrieben. Achsline 2, 3, 6 und 7 gelenkt.



Federung

MEGATRAK®. Alle Räder in Einzelradaufhängung, hydropneumatische Federung und hydraulische Blockierung. Neigungsverstellung in alle Richtungen und automatische Straßenfahrtniveaueinstellung. Federweg +170mm/-130mm.



Bereifung

14 Reifen, Größe 14.00 R25.



Lenkung

Zweikreis-Hydraulenkung mit Notlenkpumpe. Während der Straßenfahrt werden die 1., 2., 3., 6. und 7. Achse gelenkt. Separate Lenkung der 4., 5., 6., und 7. Achsline für Allradlenkung und Krabbengang.



Bremsen

Betriebsbremse: pneumatische Zweikreisbremse, auf alle Räder wirkend, Lufttrockner. Dauerbremse: Motorklappenbremse mit Kontantdrossel und Getrieberetarder. Feststellbremse: Druckluftbetätigte Federspeicherbremse auf 2., 4., 5. und 7. Achsline wirkend.



Fahrerhaus

Aluminium, 2-Mann-Fahrerhaus, Sicherheitsglas, hydraulisch gedämpfter Fahrer- und Beifahrersitz, motorabhängige Warmwasserheizung und Klimaanlage. Kontroll- und Bedienungseinrichtung für Fahrbetrieb.



Elektrische Anlage

Drehstromlichtmaschine 28 V/100 A, 2 Batterien 12 V/170 Ah, Beleuchtung und Signaleinrichtung 24 V.

* Zusatzausrüstung

- 14 x 8 x 14.
- 14 Reifen, Größe 16.00 R25 (Fahrzeugbreite 3,00 m).
- 14 Reifen, Größe 20.5 R25 (Fahrzeugbreite 3,10 m).
- Klappliege im Fahrerhaus.
- Motorunabhängige Warmwasser-Standheizung mit Motorvorwärmung.
- Zweiter Getriebeölkühler.
- Lufteinlasssperrventil (AMOT).

*Weitere Zusatzausrüstungen auf Anfrage.

Superstructure



Flèche

Flèche cinq éléments, de 16,0 m à 60,0 m, à télescopage TWIN-LOCK™. Hauteur maximum de tête de flèche 63,0 m.



Relevage

2 vérins avec clapet anti-retour, angle de relevage de - 1,2° à +82°.



Contrôleur d'état de charge et dispositif de fin de course haute crochet indépendant

Equipements électroniques de contrôle de charge, graphique, et de fin de course haute crochet indépendants avec dispositifs de signalisation sonore et visuelle et coupure des mouvements. Affichage digital d'angle et de longueur de flèche, de portée, de hauteur de tête de flèche, de moment relatif, de charge maximum autorisée, d'état de charge et d'approche de fin de course haute crochet avec coupure du mouvement de montée de treuil.



Cabine

Cabine **Aluminium**, panoramique, inclinable (environ 20°), vitrages de sécurité, siège réglable avec suspension hydraulique, chauffage autonome diesel avec minuterie 24 heures et dispositif d'air conditionné. Manipulateurs de commande de grue intégrés dans les accoudoirs. Disposition ergonomique des instruments de contrôle et de conduite. Cabine repliée derrière la machine pour déplacements routiers.



Orientation

Dispositif d'orientation avec entraînement par trois réducteurs, moteurs hydrauliques à pistons axiaux, frein à serrage automatique et commande d'orientation libre au pied.



Contrepoids

Contrepoids modulaire de 120 tonnes. Plaque de base de 20 t et éléments de 10 t. Système de dépose hydraulique.



Moteur

Mercedes-Benz OM906LA, diesel, 6 cylindres turbo, refroidi liquide, 205 kW (279 CV) à 1800 min⁻¹. (80/1269 CEE - ventilateur non débrayé). Couple max. 1100 Nm à 1200 min⁻¹. Capacité du réservoir: 300 l. Emissions pollution et fumées EUROMOT / EPA / CARB (hors route).



Système hydraulique

5 circuits séparés, 3 pompes à pistons axiaux à débit variable avec dispositif de régulation de puissance électronique, 1 pompe à pistons axiaux et débit variable pour l'orientation et 1 pompe à débit fixe pour circuits auxiliaires. Refroidisseur d'huile à commande thermostatique. Volume du réservoir: environ 1570 l.



Commande

Commande électronique de grue par système ECOS et manipulateurs électriques avec retour automatique au neutre. Ces commandes sont reliées au contrôleur d'état de charge et au dispositif de gestion du moteur thermique par système CAN-BUS.



Treuil de levage

Entraînement par moteur hydraulique à pistons axiaux, réducteur à planétaires et frein. Indicateur de rotation. Caméra de surveillance de treuil.



Installation électrique

Alternateur triphasé 28 V/100 A, 2 batteries 12 V/170 Ah.

* Equipements optionnels

- Mega-Wing-Lift
- Contrepoids supplémentaire de 40 t pour utilisation avec système Mega-Wing-Lift (Contrepoids total 160 t).
- Fléchette pour levages lourds 4/7,5 m.
- Extension treillis de 12 - 70 m par éléments de 6 m, 12 - 42 m inclinable 3°, 46 - 70 m inclinable 3°, 25°.
- Volée variable, construction en treillis 25 - 79 m par éléments de 6 m.
- Treuil auxiliaire.
- Equipement de dépose de flèche.

Porteur



Châssis

Porteur spécial, 7 lignes d'essieux, caissonné, mécanosoudé, résistant à la torsion, en acier de haute limite élastique.



Calage

4 poutres à double télescopage hydraulique, avec vérins verticaux et patins d'appui. Commande indépendante des mouvements verticaux et horizontaux des deux côtés du porteur. Caisson arrière amovible. Indicateur de niveau électronique avec système de mise à niveau automatique.



Moteur

Mercedes-Benz OM502LA, diesel, 8 cylindres turbo, refroidissement liquide, 420 kW (571 CV) à 1800 min⁻¹ (80/1269 CEE - ventilateur débrayé). Couple max. 2700 Nm à 1300 min⁻¹. Capacité du réservoir : env. 500 l.

Emissions pollution et fumées EUROMOT / EPA / CARB (hors route).



Boîte de vitesses

Boîte de vitesses automatique Allison 4800 SP. 7 rapports de marche avant et 1 rapport de marche arrière. Différentiel inter-roues. Boîte de transfert à 2 rapports et dispositif de blocage de différentiels inter-ponts.



Direction/Transmission

14 x 6 x 14.



Lignes d'essieux

7 lignes d'essieu. Lignes d'essieu 1, 4, et 5 moto-directrices, lignes d'essieu 2, 3, 6 et 7 directrices.



Suspension

MEGATRAK®. Toutes les roues sont équipées de suspension hydropneumatique indépendants et de bloqueurs hydrauliques. Commandes de mise à niveau longitudinal et transversal et dispositif de mise à niveau automatique en position route. Débattement: +170 mm/-130 mm.



Pneumatiques

14 pneus, 14.00 R25.



Direction

Direction assistée à double circuit et pompe de secours. Essieux 1, 2, 3, 6 et 7 directionnels sur route. Commande de direction indépendante pour les essieux 4, 5, 6 et 7 pour direction sur toutes les roues marche en crabe.



Freins

Frein de service: freinage pneumatique à double circuit agissant sur toutes les roues, dessiccateur. Ralentisseur par clapet sur échappement et « 5^e soupape » et ralentisseur hydraulique sur boîte de vitesses. Frein de stationnement: à serrage par ressort et desserrage pneumatique agissant sur les roues des lignes d'essieu 2, 4, 5, 6 et 7.



Cabine

Aluminium, 2 places, vitrages de sécurité, siège suspendu hydrauliquement, chauffage à eau chaude alimenté par le moteur, dispositif d'air conditionné. Equipements de conduite et instrumentation complets.



Installation électrique

Alternateur triphasé 28 V/100 A, 2 batteries 12 V/170 Ah, équipement d'éclairage et de signalisation routière 24 V.

* Equipements optionnels

- 14 x 8 x 14.
- 14 pneus 16.00 R25 (largeur du véhicule 3,00 m).
- 14 pneus 20.5 R25 (largeur du véhicule 3,10 m).
- Banquette repliable dans la cabine porteur.
- Chauffage autonome à eau chaude, avec équipement de préchauffage du moteur.
- Refroidisseur d'huile de transmission secondaire.
- Clapets de coupure d'air pour les deux moteurs.

* Autres équipements optionnels sur demande.

Características

Superestructura



Pluma

De 16,0 m a 60,0 m cinco tramos de telescopaje TWIN-LOCK™. Altura máxima en punta 63,0 m.



Elevación de pluma

Dos cilindros con válvula de seguridad. Angulo de pluma desde -1,2° hasta +82°.



Sistema Indicador del Momento de Carga y de Final de Carrera del Gancho

Indicador del Momento de Carga y de Final de Carrera del Gancho, con alarma audio-visual y bloqueo automático de las palancas. Este sistema incluye pantalla digital con indicación de ángulo de pluma, longitud, radio, altura de cabeza de pluma, momento de carga relativo, carga máxima permisible, carga real y alarma de fin de carrera del gancho con bloqueo del movimiento de elevación.



Cabina

De **Aluminio** basculable (aprox. 20°), amplia visibilidad, cristales de seguridad, asiento del operador ajustable y con suspensión hidráulica. Calefacción de gasoil con motor independiente y programador 24 horas y aire acondicionado. Controles de la grúa integrados en el apoya-brazos. Controles de operación de la grúa e instrumentación ergonómicamente situados. La cabina se recoge en la parte posterior de la grúa para su desplazamiento por carretera.



Giro

Tres reductores de giro con motores de pistón axial, engranaje planetario, freno automático con interruptor de desconexión accionado por pedal para giro libre.



Contrapeso

De 120 Tm., placa base de 20 T. y diez secciones de 10 T. Sistema hidráulico para desmontaje.



Motor

Diesel Mercedes Benz OM906LA, 6 cilindros, refrigerado por agua, turbo-alimentado, 205 Kw (279 HP) a 1.800 r.p.m. (80/1269 EWG - ventilador fijo). Par máximo: 1100 Nm a 1200 r.p.m. Capacidad del depósito de combustible: 300 litros. Emisión de gases: Según normas EUROMOT / EPA / CARB (fuera de carretera).



Sistema hidráulico

Cinco circuitos separados, con tres bombas de pistones axiales y desplazamiento variable, con control electrónico de limitación de potencia, una bomba de pistones axiales y desplazamiento variable para el giro y una bomba de desplazamiento fijo para los engranajes auxiliares. Radiador de aceite con control por termostato. Capacidad del depósito: 1570 litros.



Sistema de control

Control completamente electrónico (ECOS) de todos los movimientos de la grúa, usando palancas de control eléctrico con retorno automático a cero. Integrado con el Limitador de Cargas y el sistema de control del motor por un equipo "CAN-BUS".



Cabrestante

Motor de desplazamiento variable de pistón axial con engranaje planetario y freno. Indicador de rotación del tambor. Cámara de elevación.



Sistema eléctrico

Trifásico con alternador 28V/100A, dos baterías de 12v/170 Ah.

* Equipos opcionales

- Mega-Wing-Lift.
- Contrapeso adicional de 40 T. para utilizar con el Mega-Wing-Lift (contrapeso total 160 T.).
- Plumín de gran capacidad 4/7,5 m.
- Plumín de celosía fijo, de 12-70 m en secciones de 6 m, 12-42m angulable 3°, 46-70m angulable 3°, 25°.
- Plumín de angulación variable, de 25-79 m en secciones de 6m.
- Cabrestante Auxiliar.
- Kit de retirada de la bomba.

Chasis



Bastidor

Chasis especial de 7 ejes de construcción soldada tipo cajón, resistente a la torsión, en acero de alta resistencia.



Estabilizadores

Cuatro dobles vigas telescópicas hidráulicas con cilindros verticales y placas de apoyo. Controles independientes para los movimientos horizontales y verticales, con controles en ambos lados del chasis. Estabilizadores traseros desmontables. Indicador electrónico de nivel con sistema de nivelación automática.



Motor

Diesel Mercedes Benz OM502LA, 8 cilindros, refrigerado por agua y turbo-alimentado, 420 Kw (571 HP) a 1800 r.p.m. (80/1269 EWG - ventilador desconectado), par máximo: 2700 Nm, a 1300 r.p.m. Capacidad del Depósito de Combustible: 500 litros. Emisión de gases: Según normas EUROMOT / EPA / CARB (fuera de carretera).



Transmisión

ALLISON automática 4800 SP, 7 velocidades adelante y 1 atrás. Candado de diferencial. Caja de transferencia con 2 velocidades y bloqueo diferencial entre ejes.



Tracción/Dirección

14 x 6 x 14.



Ejes

7 ejes en línea. Ejes 1, 4 y 5 motrices y directrices. Ejes 2, 3, 6 y 7 directrices.



Suspensión

MEGATRAK®. Todas las ruedas con suspensión hidroneumática independiente y bloqueo hidráulico. Control de nivel longitudinal y transversal con sistema de nivelación automática en carretera. Desplazamiento +170 mm./ -130 mm.



Neumáticos

14 neumáticos, 14.00 R25.



Dirección

Dirección servo-asistida con doble circuito con bomba de dirección de emergencia. Los ejes 1, 2, 3, 6, y 7 son directrices para circular por carretera. Dirección separada de los ejes 4°, 5°, 6° y 7° para la dirección en todas las ruedas y conducción tipo cangrejo.



Frenos

Frenos de servicio: Neumático con doble circuito, actuando sobre todas las ruedas, secador de aire. Freno continuo: Freno sobre el escape, con estrangulamiento continuo y retardador hidráulico en la transmisión. Freno de Aparcamiento: Accionado neumáticamente y aplicado por muelle sobre los ejes 2°, 4°, 6° y 7°.



Cabina

De **Aluminio**, para dos personas, cristales de seguridad, asientos del conductor y pasajero con suspensión hidráulica, calefacción por agua caliente del motor y aire acondicionado. Mandos y panel de instrumentos para la conducción del vehículo.



Sistema eléctrico

Trifásico, alternador de 28 V/100A, 2 baterías 12 V/170 Ah. Sistema de alumbrado y señalización a 24 V.

* Equipos opcionales

- 14 x 8 x 14.
- 14 neumáticos 16.00 R25 (Anchura del vehículo: 3,00 m).
- 14 neumáticos 20.5 R25 (Anchura del vehículo: 3,10 m).
- Litera plegable en la cabina del chasis.
- Calefacción independiente del motor por agua caliente, con precalentamiento por motor.
- Refrigerador de aceite de la transmisión secundaria.
- Válvula de apagado del motor (para ambos motores)..

* Sigüientes equipos bajo demanda.

Torretta



Braccio

Da 16,0 a 60 m, 5 sezioni con sfilamento TWIN-LOCK™.
Altezza massima 63 m.



Sollevamento Braccio

2 cilindri idraulici con valvola di blocco, angolo braccio da -1,2° a +82°.



Limitatore di carico e blocco dei movimenti

Limitatore di carico e blocco dei movimenti con allarme visivo e sonoro e controllo dell'esclusione delle leve. Questo sistema è provvisto di display elettronico riportante l'angolo e la lunghezza del braccio, il raggio di lavoro, altezza di lavoro, il momento, il peso ammissibile, il peso attuale. Allarme di blocco sui movimenti e sull'argano.



Cabina

Costruita in **alluminio**, inclinabile (20° circa), grande visibilità, cristalli di sicurezza, sedile regolabile con sospensione idraulica. Riscaldamento indipendente dal motore con temporizzatore 24ore e aria condizionata. Comandi della gru integrati nei braccioli, strumentazione di controllo e servizio. Cabina ripiegabile per percorsi su strada.



Rotazione

Ottenuta con riduttore a planetario, freno automatico, pedale azionabile come controllo rotazione.



Contrappeso

Da 120 ton, diviso in varie sezioni. Sezione base da 20 ton e sezioni supplementari da 10 ton. Sistema di rimozione del contrappeso comandato direttamente dalla cabina.



Motore

Mercedes Benz OM906LA diesel, 6 cilindri, turbo 205 kW (279 PS) a 1800 giri/min (80/1269 EWG - ventola rigida). Coppia max 1100 Nm a 1200 giri/min. Capacità del serbatoio: 300 litri. Emissioni gassose allo scarico: EUROMOT / EPA / CARB (no su strada).



Impianto idraulico

5 circuiti separati, 3 pompe a portata variabile con limitazione elettronica, una pompa a portata variabile per la rotazione e una pompa a portata fissa per comandi ausiliari. Raffreddamento olio idraulico con controllo termostatico. Capacità serbatoio 1570 litri.



Comandi

Tutti i movimenti della gru sono controllati elettricamente con leve di comando a regolazione elettronica con richiamo automatico al punto zero. I comandi sono integrati con il limitatore di carico e motore, e governati dal sistema CAN-BUS.



Argano

Motore a pistoni assiali con riduttore a planetari e freno automatico. Indicatore di rotazione argano. Fotocamera argano.



Impianto elettrico

Alternatore trifase 28V/100A, 2 batterie da 12V/170 Ah.

* Accessori opzionali

- Mega-Wing-Lift.
- 40 ton di zavorra aggiuntiva per utilizzo con il Mega-Wing-Lift (contrappeso totale 160 ton).
- Jib corto da 4/7,5 m.
- Prolunga a traliccio da 12 a 70 m, composta da sezioni da 6 m. 12-42 inclinabile a 3°, 46-70m inclinabile a 3° e 25°.
- Prolunga a traliccio a volata variabile da 25 a 79 m, composta da sezioni da 8 m.
- Argano ausiliario.
- Kit rimozione braccio.

Carro



Telaio

Carro speciale, 7 assi, costruzione in acciaio sciolto ad alta resistenza, resistente alla torsione.



Stabilizzatori

4 doppie travi orizzontali con cilindri verticali e piattini d'appoggio, comandi indipendenti dei movimenti orizzontali e verticali sui due lati del carro. Cassa stabilizzatori posteriore rimovibile. Indicatori elettronici di livello con sistema di messa in bolla automatico.



Motore

Mercedes Benz OM502LA diesel, 8 cilindri, turbo 420 kW (571 PS) a 1800 giri/min (80/1269 EWG - senza ventole). Coppia max 2700 Nm a 1300 giri/min. Capacità del serbatoio: 500 litri. Emissioni gassose allo scarico: EUROMOT / EPA / CARB (no su strada).



Cambio

Cambio Allison automatico 4800SP, 7 marce avanti più una retromarcia. Bloccaggio differenziale trasversale. Riduttore ripartitore a due velocità.



Trazione/Sterzo

14 x 6 x 14.



Assali

7 assi. Gli assi 1, 4 e 5 sono sterzanti e di trazione, assi 2, 3, 6 e 7 solo sterzanti.



Sospensioni

MEGATRAK® Tutte le ruote sono montate su sospensioni idropneumatiche indipendenti con bloccaggio idraulico. Controllo del livellamento longitudinale e trasversale con livellamento automatico per la circolazione stradale. Corsa +170mm/-130mm.



Pneumatici

14 pneumatici montati in singolo 14.00 R25.



Sterzo

Doppio circuito, servoassistito idraulicamente con pompa di emergenza. Con comando per sterzo degli assi 1, 2, 3, 6 e 7. Comando separato per assi 4, 5, 6 e 7 per eseguire la sterzata combinata e a granchio.



Freni

Freno di servizio: pneumatico a doppio circuito, agente su tutte le ruote, essiccatore aria. Freno di stazionamento: scarico frenato e controllo costante valvola e retarder idraulico. Freno di parcheggio: con molle precaricate a comando pneumatico agente sugli assi 2, 4, 5 e 6.



Cabina

In **alluminio**, 2 posti, cristalli di sicurezza, sedile del guidatore e del passeggero con sospensione idraulica, riscaldamento a ricircolo (dipendente dal motore) e aria condizionata. Completa strumentazione di controllo e guida.



Impianto elettrico

Alternatore trifase 28V/100 A, 2 batterie da 12V 170Ah. Impianto d'illuminazione e segnali a 24V.

* Equipaggiamenti opzionali

- 14 x 8 x 14
- Ruote da 16.00 R 25 (Larghezza macchina 3,0m).
- Ruote da 20.5 R 25. (Larghezza macchina 3,1m).
- Letto pieghevole nella cabina
- Riscaldamento autonomo con preriscaldatore motore.
- Radiatore dell'olio della trasmissione secondario.
- Valvole di arresto del motore (per entrambi i motori).

* Altri a richiesta.

Технические характеристики

Крановая установка



Стрела

Пятисекционная стрела TWIN-LOCK™ 16,0 - 60,0 м.
Максимальная высота оголовка стрелы 63,0 м.



Подъем стрелы

2 цилиндра с предохранительным клапаном, угол наклона от -1,2° до +82°.



Ограничитель грузового момента и независимая система блокировки при переподъеме

Ограничитель грузового момента с графическим дисплеем и независимая система блокировки при переподъеме с звуковой и визуальной сигнализацией и блокировкой органов управления. Эти системы выводят на дисплей угол наклона стрелы, длину, радиус, высоту оголовка стрелы, относительный грузовой момент, максимально допустимую нагрузку, текущую нагрузку и предупреждение о возможности переподъема, которое повлечет за собой блокировку управления краном.



Кабина

Алюминиевая, наклоняемая (примерно 20°), с круговым обзором, безосколочное стекло, регулируемое место оператора с гидравлической подвеской, устройство для обогрева горячей водой с подогревом от двигателя, кондиционирование воздуха. Органы управления краном встроены в подлокотник. Эргономичная приборная панель и система управления краном. Кабина, складываемая над задней частью корпуса, для удобства перемещения по дороге.



Поворот

3 поворотных механизма с аксиально-поршневыми гидромоторами, планетарной передачей, автоматическим тормозом с ножным управлением поворотом.



Противовес

120 т: основная секция 20 т, секции по 10 т. Гидравлическая система монтажа противовесов.



Двигатель

Mercedes-Benz OM906LA, дизельный, 6-цилиндровый, с водяным охлаждением, с турбонагнетателем, 190 кВт (258 л.с.) при 1800 об/мин. (80/1269 EWG - вентилятор без возможности замены). Макс. крутящий момент: 1100 Нм при 1300 об/мин. Емкость топливного бака: 300 л. Выбросы двигателя: EUROMOT / EPA / CARB (внедорожный).



Гидравлическая система

5 отдельных контура, 3 аксиально-поршневых насоса с переменным рабочим объемом с электронным ограничителем мощности, 1 аксиально-поршневой насос с переменным рабочим объемом для поворота крана и 1 насос постоянного объема для дополнительной передачи. Охлаждитель масла, регулируемый с помощью термореле. Емкость топливного бака: 1570 л.



Система управления

Электронная система управления движением крана ECOS с электрорычагами управления и с автоматическим возвратом в нейтральное положение. Интеграция с системами LMI и управления двигателем через CAN-BUS.



Лебедка основного подъема

Аксиально-поршневой гидромотор переменного рабочего объема с планетарной передачей и тормозом. Индикатор вращения барабана. Камера лебедки.



Электросистема

Трехфазный генератор переменного тока 28 В/100 А, 2 батареи 12 В/170 А-ч.

* Дополнительное оборудование (по выбору)

- Mega-Wing-Lift.
- Дополнительный противовес 40 т для использования с Mega-Wing-Lift (суммарная масса противовеса 160 т).
- Наконечник, увеличивающий грузоподъемность, 4/7,5 м.
- Гусек, 12 - 70 м, секции 6 м. 12 - 42 м (угол наклона 3°), 46 - 70 м (угол наклона 3°, 25°).
- Маховая стрела, 25 - 79 м, секции по 6 м.
- Лебедка вспомогательного подъема.
- Комплект для демонтажа стрелы.

Тягач



Шасси

Специальное 7-осное шасси: цельносварное, устойчивое к кручению, коробчатого типа, выполненное из высокопрочной стали.



Выносные опоры

4 двойные балки с гидравлическим способом телескопирования с вертикальными цилиндрами и основаниями выносных опор. Независимый контроль горизонтального и вертикального передвижения с каждой стороны тягача. Съёмные блоки задних выносных опор. Электронный индикатор уровня с автоматической системой выравнивания.



Двигатель

Mercedes-Benz OM502LA, дизельный, 8-цилиндровый, с водяным охлаждением, с турбонагнетателем, 420 кВт (571 л.с.) при 1800 об/мин. (80/1269 EWG - сменный вентилятор). Макс. крутящий момент: 2700 Нм при 1080 об/мин. Емкость топливного бака: 500 л. Выбросы двигателя: EUROMOT / EPA / CARB (внедорожный).



Трансмиссия

Allison automatic HD4076, 7 передних и 1 задняя передача. Поперечная блокировка дифференциала. Двухступенчатая раздаточная коробка с межосевым механизмом блокировки дифференциала.



Ведущие / Управляемые оси

14 x 6 x 14.



Оси

7 осей. 1, 4 и 5 - ведомые управляемые оси (оси управления поворотом), 2, 3, 6 и 7 - управляемые оси.



Подвеска

MEGATRAK®. Подвеска всех колес гидропневматическая с гидравлической блокировкой. Контроль продольного и поперечного уровня с автоматической системой выравнивания на дороге. Диапазон +170 мм/-130 мм.



Шины

14 шин, 14,00 R25.



Рулевое управление

Двухконтурная гидравлическая схема управления поворотом с аварийным насосом системы управления. Оси 1, 2, 3, 6 и 7 управляют движением по шоссе. Отдельное управление осями 4, 5, 6 и 7 для полноприводного движения и бокового перемещения.



Тормоза

Рабочая тормозная система: пневматическая двухконтурная, на всех осях, осушитель воздуха. Постоянный тормоз: приспособление для дросселирования выхлопа при торможении двигателем и постоянный дроссельный тормоз, гидравлический замедлитель, интегрированный в трансмиссию. Стояночный тормоз: пневматически управляемый пружинный тормоз на 2, 4, 5, 6 и 7 осях.



Кабина

Алюминий, двухместная, безосколочное стекло, сиденья водителя и пассажира с гидравлической подвеской, независимое от двигателя устройство подогрева горячей водой, кондиционирование воздуха. Завершенная система управления и приборная панель.



Электросистема

Трехфазный генератор переменного тока 28 В/100 А, 2 батареи 12 В/170 А-ч. Система освещения и сигнализации 24 В.

* Дополнительное оборудование (по выбору)

- 14 x 8 x 14.
- 14 шин, 16,00 R25 (ширина машины 3,00 м).
- 14 шин, 20,5 R25 (ширина машины 3,10 м).
- Складное спальное место в кабине.
- Независимое от двигателя устройство для обогрева горячей водой с предварительным нагревом от двигателя.
- Маслоохладитель вторичной трансмиссии.
- Клапаны останова двигателя (для обоих двигателей).

* Прочее дополнительное оборудование предоставляется по запросу.

Data • Daten • Caractéristiques • Datos • Dati • Данные



Axle • Achse Essieu • Eje Asse • Оси	1	2	3	4	5	6	7	Total weight • Gesamtgewicht Poids total • Peso total Peso totale • Суммарный вес
t	12	12	12	12	12	12	12	84*

* without rear outrigger box, ohne hinteren Abstützkasten, sans les calages arrière amovibles, Sin caja de estabilizadores trasera, senza cassa stabilizzatori posteriori, Без задней коробки выносных опор.



Lifting Capacity Traglast Force de levage Capacidad de elevación Capacità di sollevamento Грузоподъемность	Sheaves Rollen Poulies Poleas Carrucole Шкивы	Weight Gewicht Poids Peso Peso Масса	Parts of line Stränge Brins Ramales de cable Numero di funi Кратность запасовки	Possible load with the crane* Mögliche Traglast am Kran* Capacité possible sur la grue* Carga posible con la gru* Portata ammissibile con la gru* Допустимая нагрузка для крана*
320 t	11	3500 kg	2 - 18/•23	231 t / 277 t •
250 t	9	3000 kg	2 - 18	231 t
200 t	7	2400 kg	2 - 15	184 t
160 t	5	1800 kg	2 - 11	136 t
100 t	3	1300 kg	2 - 7	88 t
40 t	1	850 kg	1 - 3	38 t
16 t	H/B	450 kg	1	12,5 t

* varies depending on national regulations, variiert je nach Länderschrift, fonction des réglementations nationales, variaciones dependiendo de las regulaciones nacionales, varia in funzione delle normative nazionali, изменяется в зависимости от национальных норм.

■ Requires additional boom nose sheave • Zusatzausrüstung am Rollenkopf erforderlich • Demande d'utiliser une poulie auxiliaire de tête de flèche • Requiere polea adicional en la cabeza de pluma • E' richiesto un blocco di carrucole ausiliario in testa braccio • требует наличия дополнительного шкива в оголовке стрелы

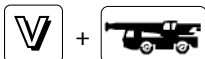

	1	2	3	4	5	6	7	R	
km/h	8,1	17,5	32,2	43,0	61,5	83,0	85,0	12,8	32 %
km/h	5,6	12,0	22,1	29,5	42,2	57,0	65,9	8,8	36 %
	14.00 R25								



	Infinitely variable • Stufenlos Progressivement variable Infinitamente variable • Infinitamente variabile Плавно-изменяемый	Rope • Seil Câble Cable • Fune Канат	Max. Single line pull • Max. Seilzug Effort maxi au brin simple Tiro máximo por ramal • Tiro max. per singola fune Макс. натяжение каната
	0 - 130 m/min Single line • Einfacher Strang Brin simple • Ramal simple • Tiro a fune singola • Однократная запасовка	24 mm/400 m (460 m)*	126 kN (110 kN)*
	0 - 130 m/min Single line • Einfacher Strang Brin simple • Ramal simple • Tiro a fune singola • Однократная запасовка	24 mm/690 m	104 kN
	0 - 1,1 min ⁻¹		
	-1,2° to + 82° approx. 130 s • ca. 130 s env. 130 s • aproximadamente 130 s aproximadamente 130 s • примерно 130 с		
	16,0 to 60,0 m approx. 420 s • ca. 420 s env. 420 s • aproximadamente 420 s aproximadamente 420 s • примерно 420 с		

* for US/Canada region

Dimensions • Abmessungen • Encombrement
Dimensiones • Dimensioni • Размеры

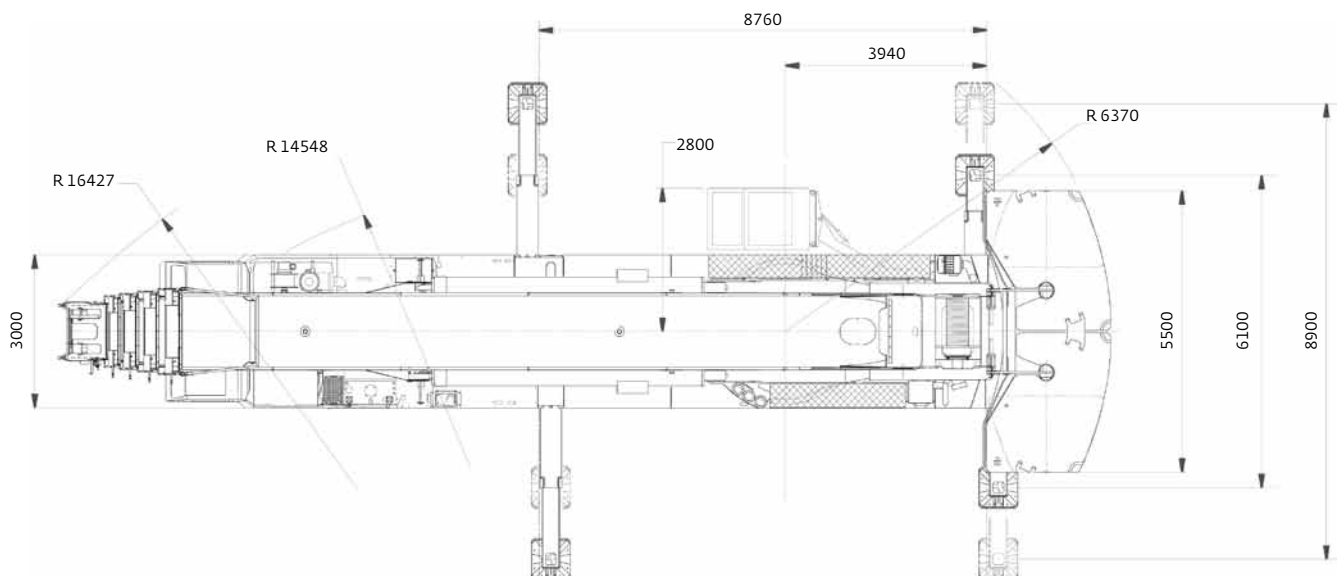
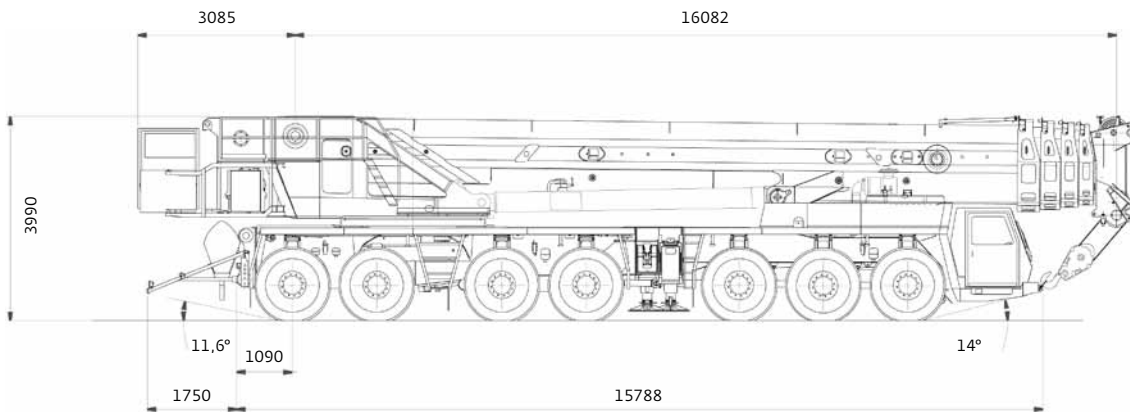
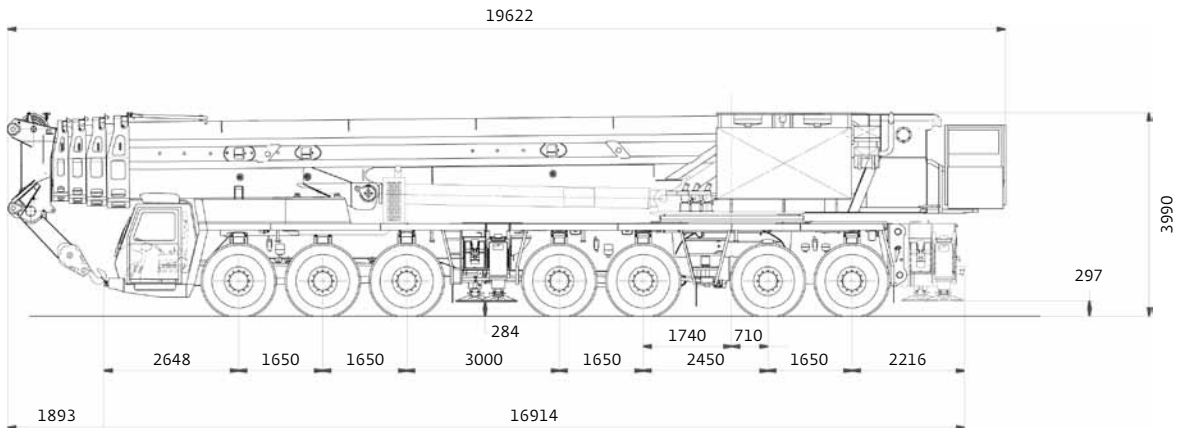

Dimensions • Abmessungen • Encombrement Dimensiones • Dimensioni • Размеры

Luffing jib • Wippspitzenausleger • Volée variable • Plumín de angulación variable • Jib a volata variable • Маневровый гусек

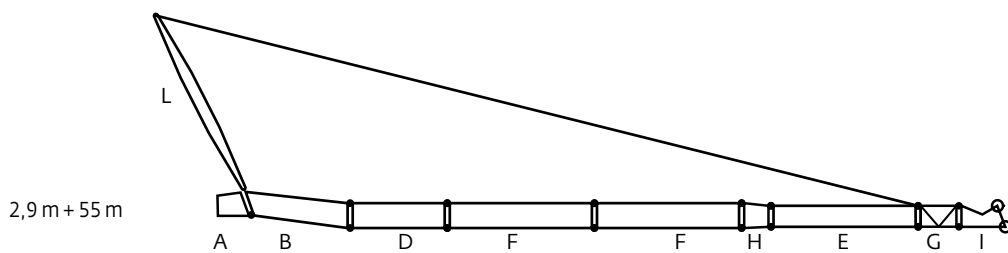
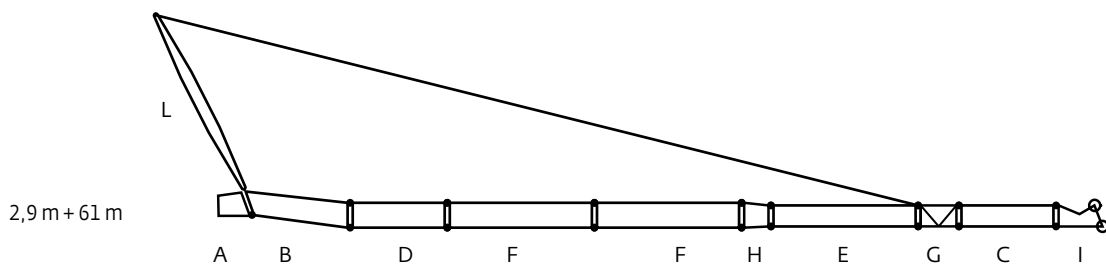
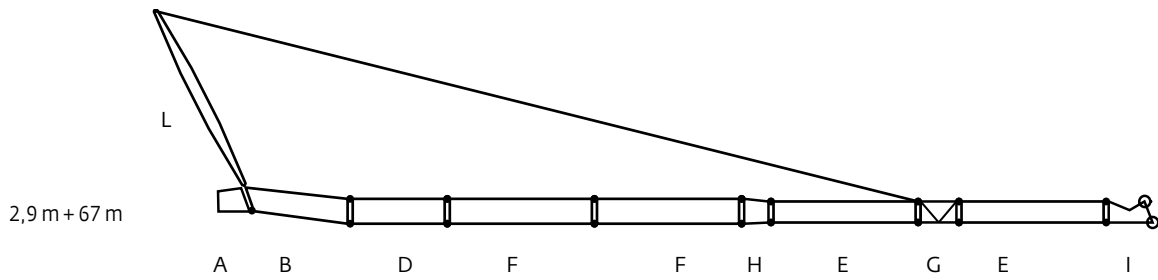
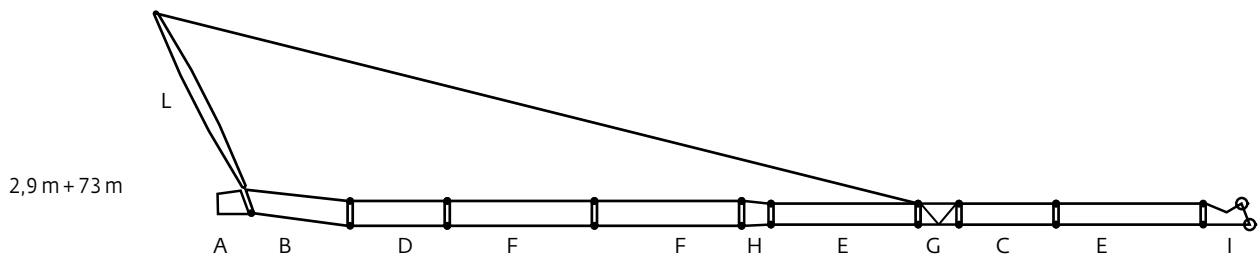
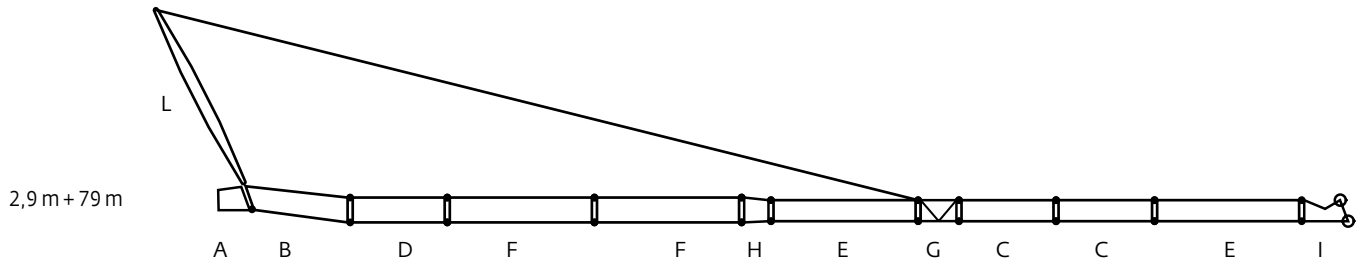

Dimensions • Abmessungen • Encombrement Dimensiones • Dimensioni • Размеры

Luffing jib • Wippspitzenausleger • Volée variable • Plumín de angulación variable • Jib a volata variable • Маневровый гусек

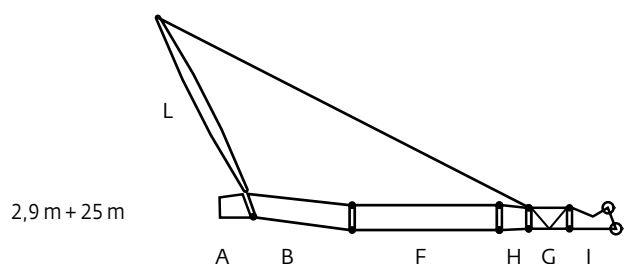
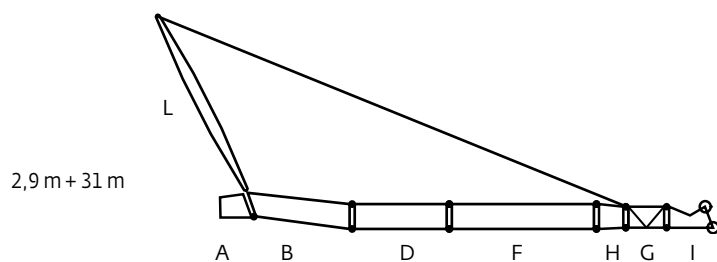
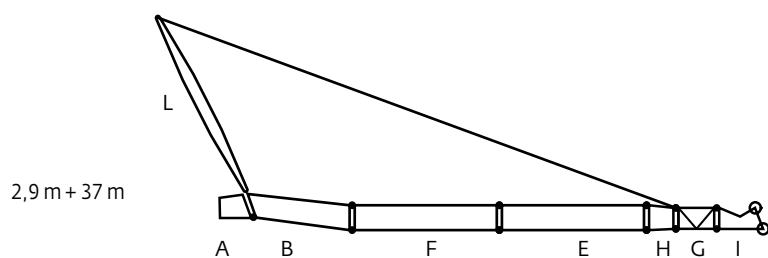
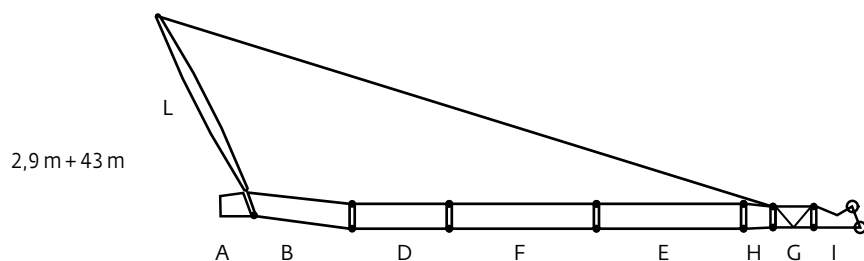
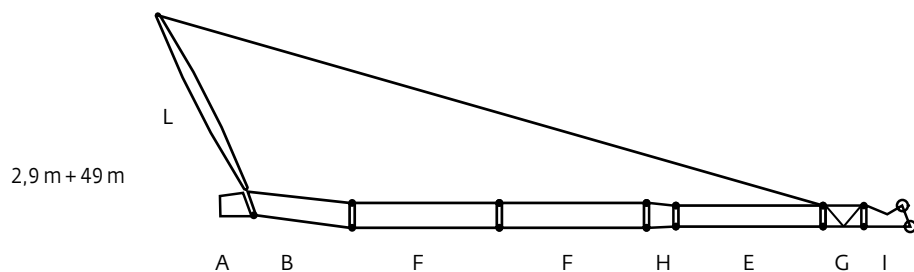

	L x W x H (m)	kg
A*	2,9 x 1,8 x 2,5	1600
B*	6,0 x 1,8 x 2,5	3700
C	6,2 x 1,5 x 1,5	900
D	6,2 x 1,8 x 1,9	1000
E	12,2 x 1,5 x 1,5	1600
F	12,2 x 1,8 x 1,9	1600
G	3,7 x 1,5 x 1,8	1600
H	1,2 x 1,8 x 1,9	500
I	3,2 x 1,5 x 2,1	1200
L	12,2 x 2,1 x 1,8	3200

* A + B is one lattice section • A+B ist eine Gittermast-Sektion
A+B constituent une seule extension treillis • A+B es una extensión de celosía
A+B è una prolunga del traliccio. • A+B - это гусек.

Dimensions • Abmessungen • Encombrement Dimensiones • Dimensioni • Размеры

Aerial rigging of luffing jib • Rüsten der Wippspitze ohne Bodenkontakt • Montage aérien de la flèche relevable • Reglaje aéreo del plumín angulable • Мановра аerea del braccio inclinabile • Подвесная сборка маховой стрелы

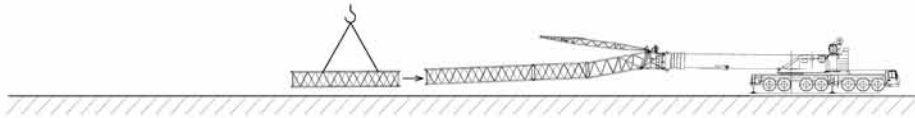

1



2



3

Remove bolt • Bolzen ziehen • Boulons amovibles
Retirar el tornillo • Rimuovere il bullone • палец

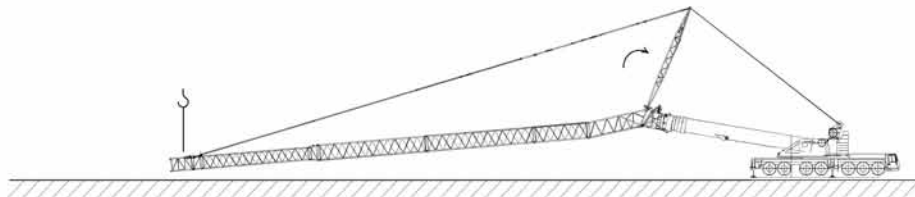
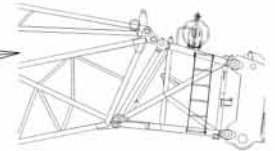

4

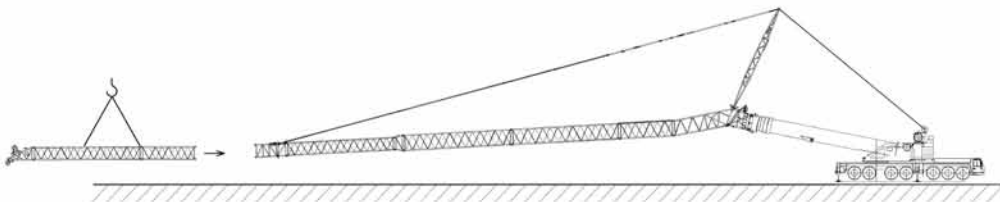

5A

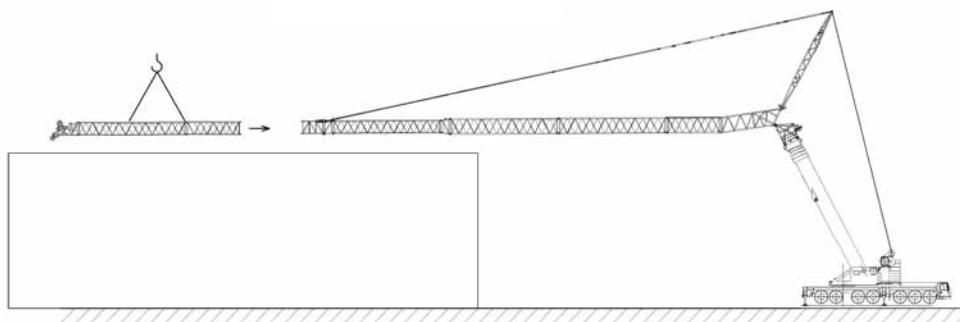

5B

Rigging on obstacles • Montage über Hindernissen • Montage sur obstacles • Reglaje en obstáculos • Мановра sopra ostacoli • Сборка на заграждениях

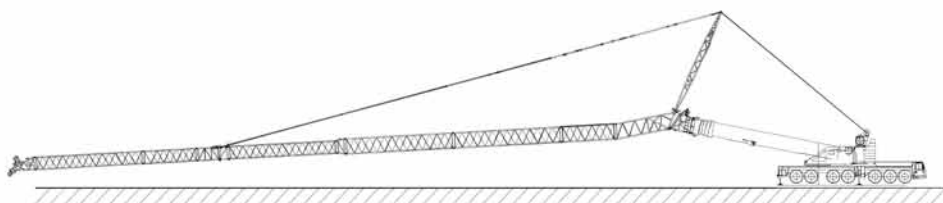

6

Dimensions • Abmessungen • Encombrement
Dimensiones • Dimensioni • Размеры

Aerial rigging of luffing jib • Rüsten der Wippspitze ohne Bodenkontakt • Montage aérien de la flèche relevable • Reglaje aéreo del plumín angulable • Мановра аerea del braccio inclinabile • Подвесная сборка маховой стрелы

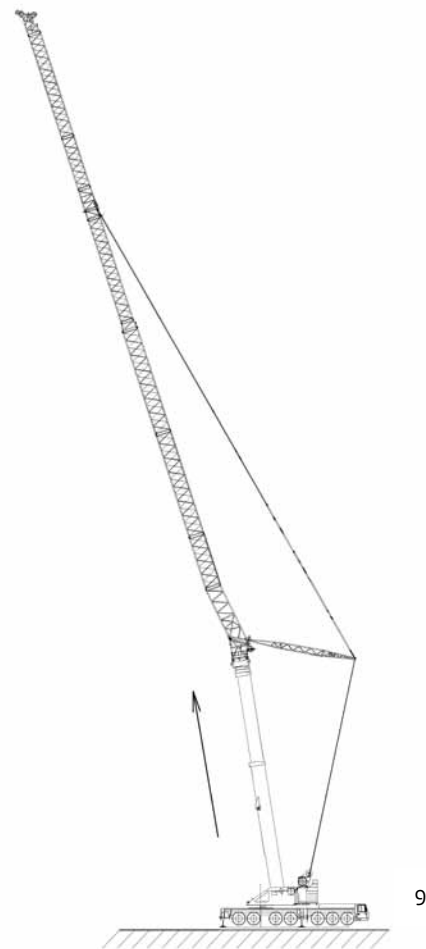
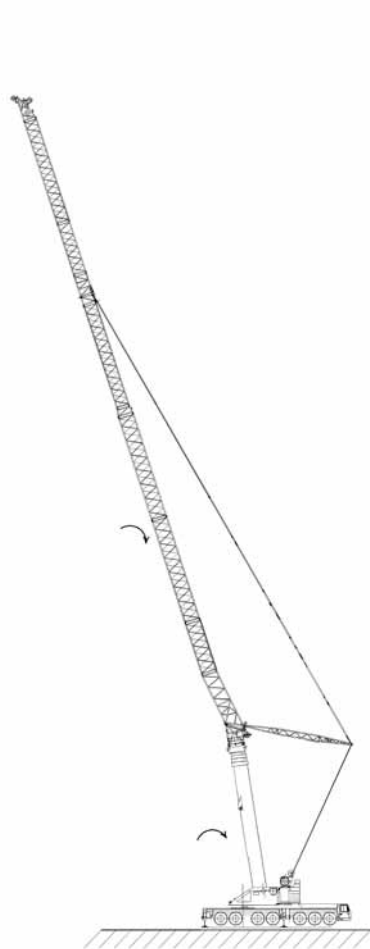
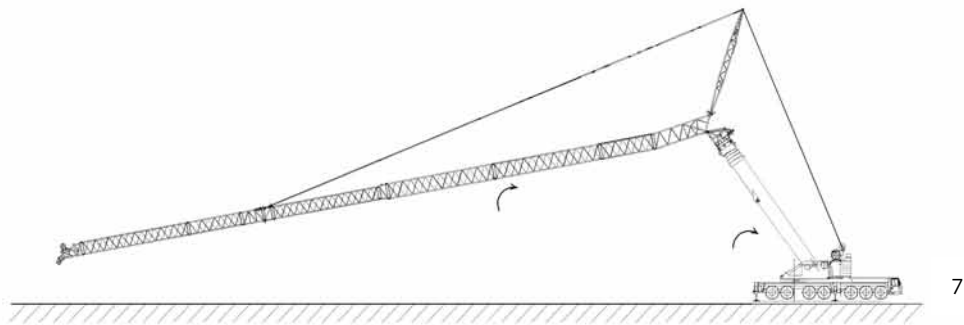

Dimensions • Abmessungen • Encombrement Dimensiones • Dimensioni • Размеры

Counterweight • Gegengewicht • Contrepoids • Contrapesos • Contrappesi • Противовес

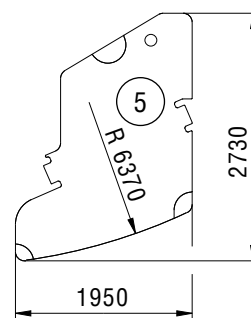
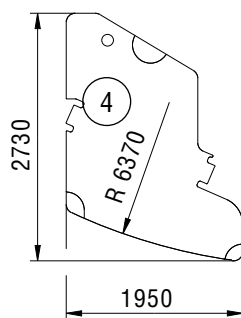
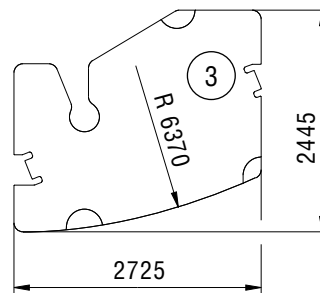
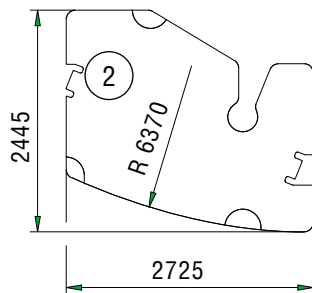
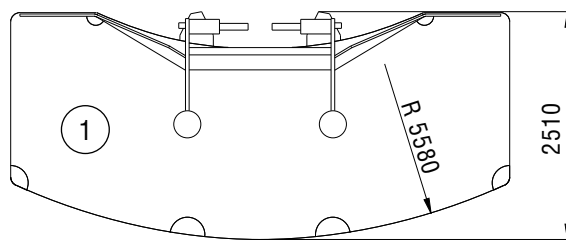
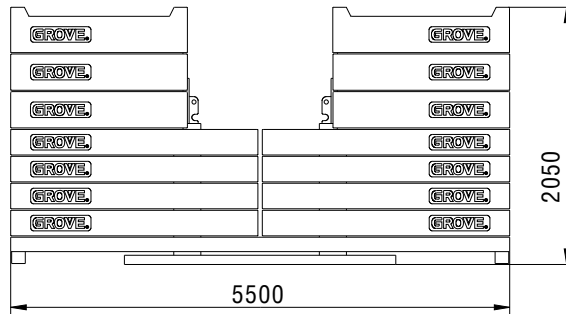

	1 20 t	2 10 t	3 10 t	4 10 t	5 10 t
20 t	X	-	-	-	-
40 t	X	X	X	-	-
60 t	X	2 X	2 X	-	-
80 t	X	3 X	3 X	-	-
100 t	X	4 X	4 X	-	-
120 t	X	4 X	4 X	X	X
140 t	X	4 X	4 X	2 X	2 X
160 t	X	4 X	4 X	3 X	3 X

Load charts • Traglasten • Capacités de levage Capacidades • Capacità • Таблицы грузоподъемности

Notes • Hinweise • Notes • Notas • Note • Примечания

The lifting capacities correspond to EN 13000:2004.

The lifting capacities likewise fulfil the requirements of ISO 4305 and DIN 15019, Part 2, with regard to stability, and DIN 15018, Part 3, and FEM 5004 with regard to strength.

The lifting capacities are given in tonnes.

Lifting capacity = Payload + weight of hook block and suspending device.

The lifting capacities for the main boom only apply with the jib dismantled.

Lifting capacities > 215 t require additional equipment.

Lifting capacities > 360 t require special equipment.

The right is reserved to modify the load-carrying capacities.

Note: The details in this brochure serve only as general information. The determinant values for the operation and the rigging of the crane are the lifting capacity tables belonging to it and the operating instructions.

Die Tragfähigkeiten entsprechen EN 13000:2004.

Die Tragfähigkeitswerte erfüllen ebenfalls die Anforderungen von ISO 4305 und DIN 15019 Teil 2 bezüglich Standsicherheit sowie von DIN 15018 Teil 3 und FEM 5004 bezüglich Festigkeit.

Die Tragfähigkeitswerte sind in Tonnen angegeben.

Tragfähigkeit = Nutzlast + Gewicht der Hakenflasche und Anschlagmittel.

Die Tragfähigkeitswerte für den Hauptausleger gelten nur bei demontierten Spitzenauslegern.

Die Tragfähigkeitswerte > 215 t erfordern eine Zusatzausrüstung.

Die Tragfähigkeitswerte > 360 t erfordern eine Sonderausrüstung.

Änderung der Tragfähigkeiten vorbehalten.

Anmerkung: Die Daten dieser Broschüre dienen nur zur allgemeinen Information. Maßgebend für den Betrieb und das Rüsten des Kranes sind die zugehörigen

Tragfähigkeitstabellen und die Bedienungsanleitung.

Les capacités de levage sont conformes à la norme EN 13000:2004.

Les capacités de levage respectent également les exigences des normes ISO 4305 et DIN 15019, paragraphe 2, relatives à la stabilité, ainsi que celles des normes DIN 15018 paragraphe 3 et FEM 5004 relatives à la résistance.

Les capacités de levage sont exprimées en tonnes.

Capacité = charge utile + poids du crochet et du dispositif d'élingage.

Les capacités de levage de la flèche principale ne sont valables que lorsque la fléchette est démontée.

Des capacités de levage > 215 tonnes exigent l'utilisation d'un dispositif supplémentaire.

Des capacités de levage > 360 tonnes exigent l'utilisation d'un dispositif spécial.

Le constructeur se réserve le droit d'apporter des modifications à ces capacités de levage.

Remarque : Les données de cette brochure ne sont fournies qu'à titre d'information générale. Les paramètres pour l'utilisation et le montage de la grue sont les tableaux des charges spécifiques et les consignes d'utilisation.

Las capacidades de carga corresponden a EN 13000:2004.

Asimismo los valores de carga cumplen las disposiciones de las normas ISO 4305 y DIN 15019, 2.ª parte, respecto a la estabilidad, y DIN 15018, 3.ª parte, y FEM 5004 respecto a la fuerza.

Los valores de carga se dan en toneladas.

Capacidad de carga = Carga + peso de la garrucha del gancho y del mecanismo de elevación.

Los valores de carga para la pluma principal sólo son válidos cuando no hay plumines instalados.

Valores de carga > 215 t requieren un mecanismo de elevación suplementario.

Valores de carga > 360 t requieren una unidad especial.

Se reserva el derecho a modificar las capacidades de carga.

Nota: Los detalles contenidos en este folleto sirven sólo como información general. Los valores determinantes para el funcionamiento y el reglaje de la grúa son los cuadros de cargas correspondientes, así como las instrucciones de funcionamiento.

Le tabelle di portata sono conformi alle norme EN 13000:2004.

I valori delle tabelle di portata sono conformi anche ai requisiti delle norme ISO 4305 e DIN 15019, Parte 2, per quanto riguarda la stabilità, ed alle norme DIN 15018, Parte 3, e FEM 5004 per quanto riguarda il calcolo di resistenza della struttura.

I valori di portata sono indicati in tonnellate.

Capacità di portata = carico utile + peso del gancio e accessori di sollevamento.

I valori delle tabelle di portata per il braccio principale si applicano solo con le punte bracci smontate.

Valori di portata > 215 t richiedono un'attrezzatura supplementare.

Valori di portata > 360 t richiedono un'unità speciale.

Si riserva il diritto di modificare i valori di portata.

Nota: i dettagli forniti nel presente opuscolo servono solo come informazioni di carattere generale. I valori determinanti per il funzionamento e l'utilizzo della gru sono le corrispondenti tabelle di portata e le istruzioni di utilizzo..

Грузоподъемность соответствует EN 13000:2004.

Кроме того, грузоподъемность удовлетворяет требованиям ISO 4305 и DIN 15019 (часть 2) в отношении устойчивости, и DIN 15018, (часть 3), и FEM 5004 в отношении прочности материала.

Грузоподъемность приведена в тоннах.

Грузоподъемность = Полезный груз + вес крюкового блока и устройства для подвешивания.

Грузоподъемность основной стрелы только при сложенном удлинителе.

Грузоподъемность > 215 т необходимо дополнительное оборудование.

Грузоподъемность > 360 т необходимо специальное оборудование.

Оставляем за собой право изменять грузоподъемность.

Примечание: В данной брошюре приведена только общая информация. решающий фактор в работе и монтаже крана – таблицы грузоподъемности и инструкции по эксплуатации.

Load charts • Traglasten • Capacités de levage Capacidades • Capacità • Таблицы грузоподъемности

Working range • Arbeitsbereiche • Diagramme de levage • Gama de trabajo • Area di lavoro • Грузовысотные характеристики



16,0 – 60,0 m



8,9 m



360°

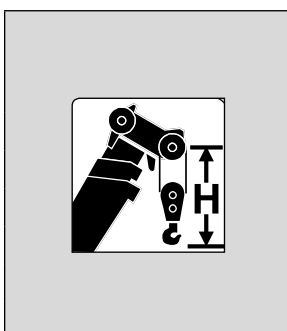
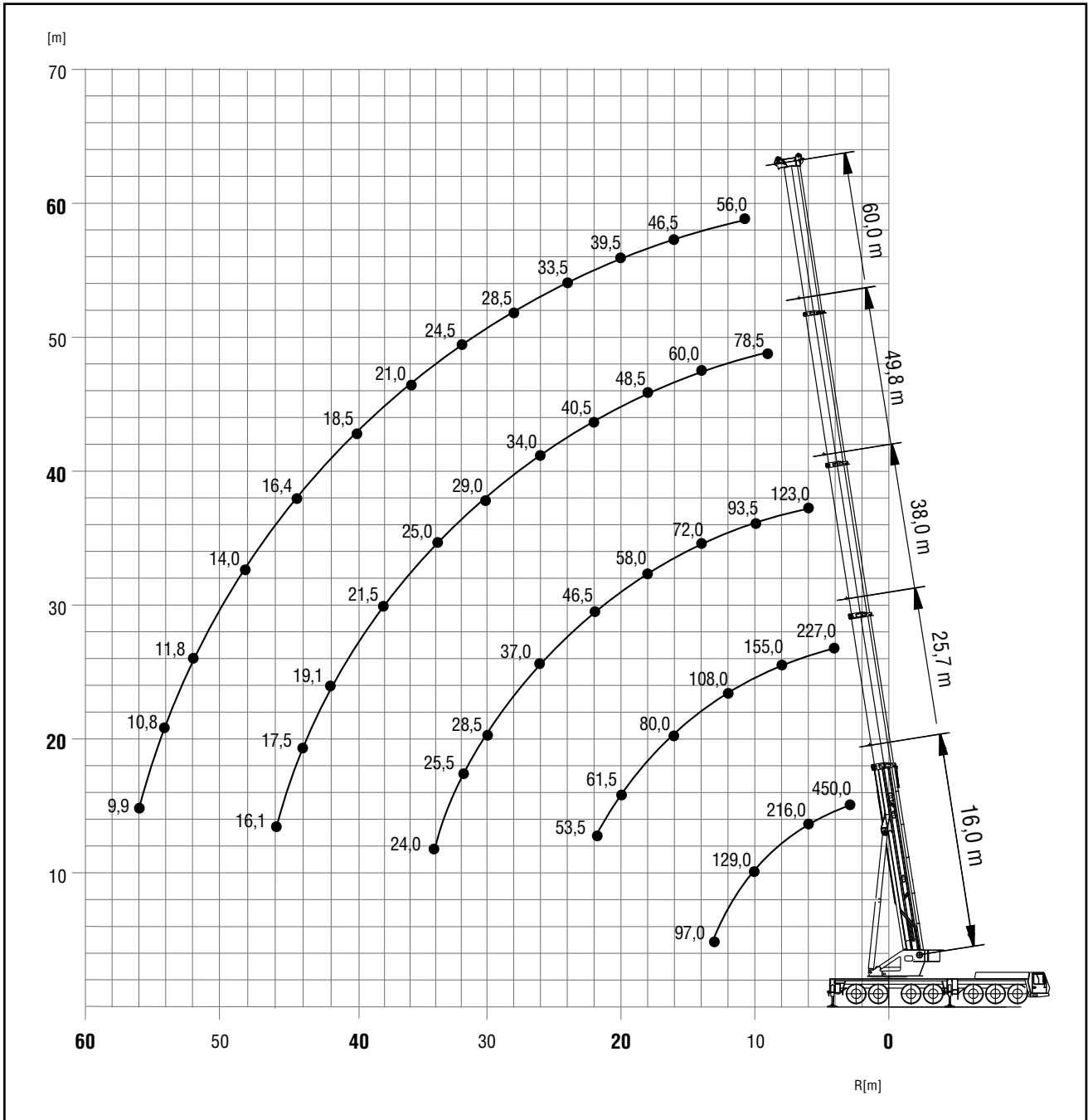

Hook block • Hakenflasche • Crochet-moufle • Gancho • Ganci • Крюковой блок (t)

H (mm)

320 D	4050
250 D	3950
200 D	3650
160 D	3650
100 D/E	3300
40 D/E	3200
16 H/B	2600

Load charts • Traglasten • Capacités de levage Capacidades • Capacità • Таблицы грузоподъемности

Telescopic boom • Teleskopausleger • Flèche principale • Pluma telescópica • Braccio telescopico • Телескопическая стрела



16,0 – 60,0 m



8,9 m



360°



120 t



EN 13000

m	16,0*	16,0	20,9	25,7	30,5	35,3	38,0	40,2	45,0	49,8	54,6	60,0
2,5	**450,0/360,0	-	-	-	-	-	-	-	-	-	-	-
3,0	295,0	295,0	270,0	-	-	-	-	-	-	-	-	-
4,0	269,0	252,0	242,0	227,0	-	-	-	-	-	-	-	-
5,0	250,0	218,0	218,0	207,0	195,0	-	-	-	-	-	-	-
6,0	216,0	192,0	193,0	191,0	178,0	161,0	123,0	-	-	-	-	-
7,0	186,0	170,0	172,0	172,0	165,0	154,0	116,0	115,0	-	-	-	-
8,0	162,0	153,0	155,0	155,0	154,0	146,0	108,0	107,0	93,0	-	-	-
9,0	144,0	139,0	140,0	140,0	139,0	138,0	101,0	99,5	89,0	78,5	-	-
10,0	129,0	127,0	128,0	128,0	127,0	129,0	93,5	93,5	83,5	75,0	66,0	-
11,0	116,0	116,0	118,0	118,0	117,0	118,0	86,5	87,0	78,5	71,5	63,5	56,0
12,0	106,0	106,0	107,0	108,0	107,0	108,0	81,5	81,0	73,0	67,5	61,0	54,5
13,0	97,0	97,0	98,5	98,5	100,0	99,5	77,0	76,5	69,5	64,0	58,5	53,0
14,0	-	-	91,0	91,0	92,5	91,5	72,0	72,5	65,5	60,0	56,0	51,0
15,0	-	-	85,0	86,0	85,5	85,0	67,0	68,0	61,5	57,0	53,5	49,0
16,0	-	-	79,0	80,0	79,5	79,0	64,0	64,5	58,0	54,5	51,0	46,5
18,0	-	-	-	70,0	70,0	69,0	58,0	59,5	52,5	48,5	46,5	43,0
20,0	-	-	-	61,5	61,5	60,5	51,5	54,5	47,5	44,5	42,0	39,5
22,0	-	-	-	53,5	53,5	52,0	46,5	50,0	43,0	40,5	39,0	36,0
24,0	-	-	-	-	46,5	45,5	42,0	47,0	39,5	36,5	35,5	33,5
26,0	-	-	-	-	41,5	40,0	37,0	41,5	36,0	34,0	32,5	31,0
28,0	-	-	-	-	-	37,0	32,5	37,0	33,5	31,5	30,0	28,5
30,0	-	-	-	-	-	34,5	28,5	33,5	31,5	29,0	28,0	26,0
32,0	-	-	-	-	-	31,0	25,5	30,0	29,5	27,0	26,0	24,5
34,0	-	-	-	-	-	-	24,0	27,0	27,5	25,0	23,5	22,5
36,0	-	-	-	-	-	-	-	25,0	25,0	23,0	22,5	21,0
38,0	-	-	-	-	-	-	-	-	23,0	21,5	21,0	19,6
40,0	-	-	-	-	-	-	-	-	21,0	20,0	19,8	18,5
42,0	-	-	-	-	-	-	-	-	-	19,1	18,3	17,4
44,0	-	-	-	-	-	-	-	-	-	17,5	16,7	16,4
46,0	-	-	-	-	-	-	-	-	-	16,1	15,3	15,3
48,0	-	-	-	-	-	-	-	-	-	-	14,0	14,0
50,0	-	-	-	-	-	-	-	-	-	-	12,8	12,8
52,0	-	-	-	-	-	-	-	-	-	-	-	11,8
54,0	-	-	-	-	-	-	-	-	-	-	-	10,8
56,0	-	-	-	-	-	-	-	-	-	-	-	9,9

** Over rear with special equipment • Nach hinten mit Sonderausrüstung • En arrière avec équipement spécial • Por la parte trasera con equipo especial • Sul posteriore con equipaggiamento speciale • Над задней частью

† 8,76 x 6,10 m. Over rear • nach hinten • en arrière • por la parte trasera • sul posteriore • Над задней частью

Lifting capacities >215 t require additional equipment • Traglasten >215 t erfordern Zusatzausrüstung • Capacités de levage >215 t demandent équipement supplémentaire • Capacidades de elevación >215 Tm require equipo adicional • Capacità >215 t con equipaggiamento ausiliario • Грузоподъемность > 215 т необходимо дополнительное оборудование

Load charts • Traglasten • Capacités de levage Capacidades • Capacità • Таблицы грузоподъемности

Telescopic boom • Teleskopausleger • Flèche principale • Pluma telescópica • Braccio telescopico • Телескопическая стрела



16,0 – 60,0 m



8,9 m



360°



100 t



EN 13000

m	16,0*	16,0	20,9	25,7	30,5	35,3	38,0	40,2	45,0	49,8	54,6	60,0
2,5	**450,0 / 360,0	-	-	-	-	-	-	-	-	-	-	-
3,0	295,0	289,0	270,0	-	-	-	-	-	-	-	-	-
4,0	269,0	246,0	242,0	227,0	-	-	-	-	-	-	-	-
5,0	245,0	213,0	213,0	207,0	195,0	-	-	-	-	-	-	-
6,0	205,0	187,0	188,0	188,0	178,0	161,0	123,0	-	-	-	-	-
7,0	176,0	166,0	168,0	168,0	165,0	154,0	116,0	115,0	-	-	-	-
8,0	154,0	149,0	151,0	151,0	150,0	146,0	108,0	107,0	93,0	-	-	-
9,0	136,0	135,0	137,0	137,0	136,0	137,0	101,0	99,5	89,0	78,5	-	-
10,0	122,0	122,0	124,0	124,0	123,0	124,0	93,5	93,5	83,5	75,0	66,0	-
11,0	110,0	110,0	112,0	112,0	113,0	113,0	86,5	87,0	78,5	71,5	63,5	56,0
12,0	100,0	100,0	102,0	103,0	103,0	103,0	81,5	81,0	73,0	67,5	61,0	54,5
13,0	92,0	92,0	94,0	95,0	95,0	94,0	77,0	76,5	69,5	64,0	58,5	53,0
14,0	-	-	87,0	87,5	87,5	86,5	72,0	72,5	65,5	60,0	56,0	51,0
15,0	-	-	80,0	81,0	80,5	79,5	67,0	68,0	61,5	57,0	53,5	49,0
16,0	-	-	73,5	74,5	74,5	73,5	64,0	64,5	58,0	54,5	51,0	46,5
18,0	-	-	-	62,5	62,0	61,0	57,5	59,5	52,5	48,5	46,5	43,0
20,0	-	-	-	53,0	52,5	51,5	48,0	53,0	47,5	44,5	42,0	39,5
22,0	-	-	-	45,5	45,5	46,0	41,0	46,0	43,0	40,5	39,0	36,0
24,0	-	-	-	-	39,5	41,0	35,0	40,0	38,5	36,5	35,5	33,5
26,0	-	-	-	-	35,0	36,5	32,5	35,0	35,5	33,5	32,5	31,0
28,0	-	-	-	-	-	32,0	29,5	31,0	31,5	30,0	30,0	28,5
30,0	-	-	-	-	-	28,5	26,5	28,0	28,0	28,0	27,0	26,0
32,0	-	-	-	-	-	26,0	23,5	26,0	25,0	25,0	24,0	24,0
34,0	-	-	-	-	-	-	21,0	23,5	22,5	22,5	21,5	21,5
36,0	-	-	-	-	-	-	-	21,5	20,5	20,0	19,3	19,4
38,0	-	-	-	-	-	-	-	-	18,8	18,1	17,3	17,4
40,0	-	-	-	-	-	-	-	-	17,1	16,4	15,6	15,7
42,0	-	-	-	-	-	-	-	-	-	14,9	14,1	14,1
44,0	-	-	-	-	-	-	-	-	-	13,5	12,7	12,8
46,0	-	-	-	-	-	-	-	-	-	12,3	11,5	11,5
48,0	-	-	-	-	-	-	-	-	-	-	10,4	10,4
50,0	-	-	-	-	-	-	-	-	-	-	9,4	9,4
52,0	-	-	-	-	-	-	-	-	-	-	-	8,5
54,0	-	-	-	-	-	-	-	-	-	-	-	7,6
56,0	-	-	-	-	-	-	-	-	-	-	-	6,9

** Over rear with special equipment • Nach hinten mit Sonderausrüstung • En arrière avec équipement spécial • Por la parte trasera con equipo especial • Sul posteriore con equipaggiamento speciale • Над задней частью

† 8,76 x 6,10 m. Over rear • nach hinten • en arrière • por la parte trasera • sul posteriore • Над задней частью

Lifting capacities >215 t require additional equipment • Traglasten >215 t erfordern Zusatzausrüstung • Capacités de levage >215 t demandent équipement supplémentaire • Capacidades de elevación >215 Tm require equipo adicional • Capacità >215 t con equipaggiamento ausiliario • Грузоподъемность > 215 т необходимо дополнительное оборудование

Load charts • Traglasten • Capacités de levage Capacidades • Capacità • Таблицы грузоподъемности

Telescopic boom • Teleskopausleger • Flèche principale • Pluma telescópica • Braccio telescopico • Телескопическая стрела



16,0 – 60,0 m



8,9 m



360°



80 t



EN 13000

m	16,0*	16,0	20,9	25,7	30,5	35,3	38,0	40,2	45,0	49,8	54,6	60,0
2,5	**450,0 / 360,0	-	-	-	-	-	-	-	-	-	-	-
3,0	295,0	283,0	270,0	-	-	-	-	-	-	-	-	-
4,0	269,0	240,0	240,0	227,0	-	-	-	-	-	-	-	-
5,0	232,0	207,0	209,0	207,0	195,0	-	-	-	-	-	-	-
6,0	194,0	182,0	184,0	184,0	178,0	161,0	123,0	-	-	-	-	-
7,0	167,0	162,0	163,0	163,0	163,0	154,0	116,0	115,0	-	-	-	-
8,0	146,0	145,0	147,0	147,0	146,0	146,0	108,0	107,0	93,0	-	-	-
9,0	129,0	129,0	130,0	131,0	131,0	131,0	101,0	99,5	89,0	78,5	-	-
10,0	115,0	115,0	117,0	117,0	118,0	118,0	93,5	93,5	83,5	75,0	66,0	-
11,0	104,0	104,0	106,0	107,0	107,0	105,0	86,5	87,0	78,5	71,5	63,5	56,0
12,0	93,5	93,5	96,5	97,5	97,0	94,0	81,5	81,0	73,0	67,5	61,0	54,5
13,0	83,5	82,5	87,0	88,5	88,0	84,5	77,0	76,5	69,5	64,0	58,5	53,0
14,0	-	-	77,0	78,5	78,0	76,5	70,5	72,5	65,5	60,0	56,0	51,0
15,0	-	-	69,0	70,0	70,0	68,5	64,0	68,0	61,5	57,0	53,5	49,0
16,0	-	-	62,0	63,0	63,0	62,0	58,0	63,5	58,0	54,5	51,0	46,5
18,0	-	-	-	52,0	52,0	54,0	47,0	52,5	49,5	48,5	46,5	43,0
20,0	-	-	-	44,5	43,5	45,0	42,0	44,0	44,5	42,0	42,0	39,5
22,0	-	-	-	37,5	39,0	38,5	36,0	37,5	38,0	37,5	36,5	36,0
24,0	-	-	-	-	33,5	33,0	31,0	33,5	32,5	32,5	31,5	31,5
26,0	-	-	-	-	29,5	29,0	26,5	29,5	29,0	28,0	27,5	27,5
28,0	-	-	-	-	-	26,0	24,5	26,0	25,5	24,5	24,0	24,0
30,0	-	-	-	-	-	23,0	23,0	23,0	22,5	21,5	21,0	21,0
32,0	-	-	-	-	-	20,5	21,0	20,5	19,8	19,1	18,4	18,4
34,0	-	-	-	-	-	-	18,7	18,2	17,7	16,9	16,2	16,3
36,0	-	-	-	-	-	-	-	16,4	15,8	15,0	14,3	14,4
38,0	-	-	-	-	-	-	-	-	14,1	13,4	12,6	12,7
40,0	-	-	-	-	-	-	-	-	12,7	12,0	11,2	11,2
42,0	-	-	-	-	-	-	-	-	-	10,7	9,9	9,9
44,0	-	-	-	-	-	-	-	-	-	9,5	8,7	8,8
46,0	-	-	-	-	-	-	-	-	-	8,6	7,7	7,7
48,0	-	-	-	-	-	-	-	-	-	-	6,8	6,8
50,0	-	-	-	-	-	-	-	-	-	-	5,9	5,9
52,0	-	-	-	-	-	-	-	-	-	-	-	5,2
54,0	-	-	-	-	-	-	-	-	-	-	-	4,5
56,0	-	-	-	-	-	-	-	-	-	-	-	3,9

** Over rear with special equipment • Nach hinten mit Sonderausrüstung • En arrière avec équipement spécial • Por la parte trasera con equipo especial • Sul posteriore con equipaggiamento speciale • Над задней частью

† 8,76 x 6,10 m. Over rear • nach hinten • en arrière • por la parte trasera • sul posteriore • Над задней частью

Lifting capacities >215 t require additional equipment • Traglasten >215 t erfordern Zusatzausrüstung • Capacités de levage >215 t demandent équipement supplémentaire • Capacidades de elevación >215 Tm require equipo adicional • Capacità >215 t con equipaggiamento ausiliario • Грузоподъемность > 215 т необходимо дополнительное оборудование

Load charts • Traglasten • Capacités de levage Capacidades • Capacità • Таблицы грузоподъемности

Telescopic boom • Teleskopausleger • Flèche principale • Pluma telescópica • Braccio telescopico • Телескопическая стрела



16,0 – 60,0 m



8,9 m



360°



60 t



EN 13000

m	16,0	20,9	25,7	30,5	35,3	38,0	40,2	45,0	49,8	54,6	60,0
3,0	276,0	270,0	-	-	-	-	-	-	-	-	-
4,0	234,0	234,0	227,0	-	-	-	-	-	-	-	-
5,0	202,0	203,0	204,0	195,0	-	-	-	-	-	-	-
6,0	177,0	179,0	179,0	178,0	161,0	123,0	-	-	-	-	-
7,0	157,0	159,0	159,0	158,0	154,0	116,0	115,0	-	-	-	-
8,0	137,0	139,0	139,0	141,0	133,0	108,0	107,0	93,0	-	-	-
9,0	120,0	122,0	125,0	121,0	113,0	101,0	99,5	89,0	78,5	-	-
10,0	103,0	108,0	110,0	105,0	98,0	90,5	92,5	83,5	75,0	66,0	-
11,0	87,5	92,0	94,0	92,0	86,0	78,5	83,5	77,5	71,5	63,5	56,0
12,0	75,5	79,5	81,5	81,0	75,5	68,5	74,5	68,5	66,5	61,0	54,5
13,0	65,5	70,0	71,5	71,0	69,5	62,0	66,5	62,5	59,5	58,5	53,0
14,0	-	61,5	63,5	63,0	64,0	58,0	60,0	58,5	54,5	53,0	51,0
15,0	-	55,0	56,0	56,0	58,0	53,5	54,0	53,0	51,0	48,5	46,5
16,0	-	48,5	51,0	52,0	51,5	48,5	49,5	48,5	46,5	44,0	42,5
18,0	-	-	41,0	42,5	42,0	39,5	42,5	41,5	39,0	37,0	36,0
20,0	-	-	34,0	35,5	35,5	34,5	35,5	35,0	33,5	31,5	31,0
22,0	-	-	28,5	30,0	30,0	30,5	30,0	29,5	28,5	27,5	26,5
24,0	-	-	-	25,5	25,5	26,0	25,5	25,0	24,0	23,5	23,0
26,0	-	-	-	22,0	22,0	22,5	22,0	21,5	20,5	20,0	20,0
28,0	-	-	-	-	19,3	19,6	19,1	18,6	17,8	17,1	17,2
30,0	-	-	-	-	16,9	17,1	16,7	16,2	15,4	14,7	14,8
32,0	-	-	-	-	14,8	15,1	14,6	14,1	13,4	12,6	12,7
34,0	-	-	-	-	-	13,3	12,9	12,3	11,6	10,8	10,9
36,0	-	-	-	-	-	-	11,4	10,8	10,0	9,3	9,4
38,0	-	-	-	-	-	-	-	9,4	8,7	7,9	8,0
40,0	-	-	-	-	-	-	-	8,3	7,5	6,7	6,8
42,0	-	-	-	-	-	-	-	-	6,5	5,7	5,7
44,0	-	-	-	-	-	-	-	-	5,6	4,7	4,8
46,0	-	-	-	-	-	-	-	-	4,8	3,9	3,9
48,0	-	-	-	-	-	-	-	-	-	3,1	3,2
50,0	-	-	-	-	-	-	-	-	-	2,5	2,5
52,0	-	-	-	-	-	-	-	-	-	-	1,9



16,0 – 60,0 m



8,9 m



360°



0 t



EN 13000

m	16,0	20,9	25,7	27,7	30,5	35,3	38,0	40,15	44,98
3,0	255,0	254,0	-	-	-	-	-	-	-
4,0	216,0	208,0	174,0	130,0	-	-	-	-	-
5,0	156,0	131,0	109,0	106,0	95,0	-	-	-	-
6,0	93,0	84,0	75,5	74,0	68,0	60,5	57,5	-	-
7,0	62,5	59,5	56,0	55,0	51,5	47,0	45,0	42,0	-
8,0	45,0	45,0	43,0	42,5	40,5	37,5	36,0	34,0	30,0
9,0	34,0	35,0	34,5	34,0	33,0	30,5	29,5	28,0	24,5
10,0	26,0	27,5	28,0	28,0	27,0	25,5	24,5	23,0	20,5
11,0	20,5	22,5	23,0	23,0	22,5	21,0	21,0	19,3	17,1
12,0	15,3	18,1	19,0	19,2	18,9	17,9	17,6	16,3	14,4
13,0	11,3	14,8	15,9	16,1	16,0	15,1	14,9	13,8	12,0
14,0	-	12,0	13,2	13,5	13,5	12,8	12,7	11,7	10,1
15,0	-	9,6	11,1	11,3	11,4	10,9	10,8	9,8	8,4
16,0	-	7,5	9,2	9,5	9,7	9,2	9,2	8,3	6,9
18,0	-	-	6,2	6,5	6,8	6,5	6,5	5,7	4,5
20,0	-	-	3,8	4,2	4,6	4,3	4,4	3,7	2,5
22,0	-	-	1,9	2,3	2,9	2,6	2,8	2,0	-

Lifting capacities >215 t require additional equipment • Traglasten >215 t erfordern Zusatzausrüstung • Capacités de levage >215t demandent équipement supplémentaire • Capacidades de elevación >215 Tm requiere equipo adicional • Capacità >215 t con equipaggiamento ausiliario • Грузоподъемность >215 т необходимо дополнительное оборудование

Load charts • Traglasten • Capacités de levage Capacidades • Capacità • Таблицы грузоподъемности

Mega-Wing-Lift
Working range • Arbeitsbereiche • Diagramme de levage • Gama de trabajo • Area di lavoro • Грузовысотные характеристики

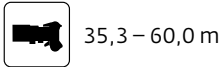

35,3 – 60,0 m



8,9 m



360°

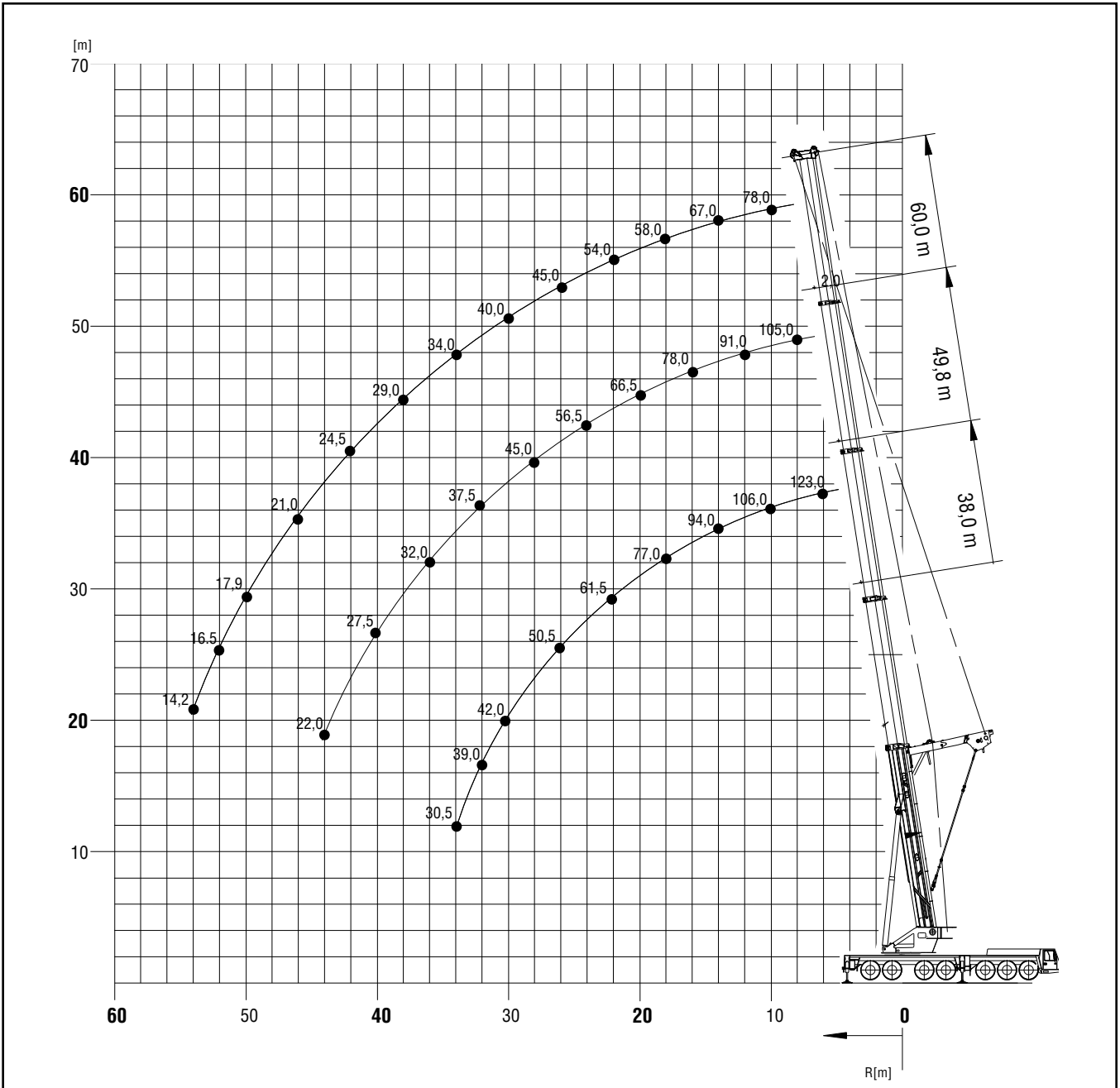

	Hook block • Hakenflasche • Crochet-moufle • Gancho • Ganci • Крюковой блок (t)	H (mm)
	320 D	4050
	250 D	3950
	200 D	3650
	160 D	3650
	100 D/E	3300
	40 D/E	3200
	16 H/B	2600

Load charts • Traglasten • Capacités de levage Capacidades • Capacità • Таблицы грузоподъемности

Mega-Wing-Lift

Telescopic boom • Teleskopausleger • Flèche principale • Pluma telescópica • Braccio telescopico • Телескопическая стрела



35,3 – 60,0 m



8,9 m



360°



160 t



EN 13000

m	35,3	38,0	40,2	45,0	49,8	54,6	60,0
5,0	166,0	-	-	-	-	-	-
6,0	160,0	123,0	150,0	-	-	-	-
7,0	152,0	118,0	145,0	140,0	-	-	-
8,0	144,0	114,0	137,0	131,0	105,0	-	-
9,0	136,0	110,0	128,0	123,0	101,0	97,5	-
10,0	129,0	106,0	121,0	115,0	98,0	93,5	78,0
11,0	121,0	103,0	115,0	109,0	94,5	89,5	75,0
12,0	111,0	100,0	109,0	104,0	91,0	85,0	72,0
13,0	105,0	97,0	103,0	99,0	87,5	82,0	69,5
14,0	98,5	94,0	97,5	94,5	84,0	78,5	67,0
15,0	92,0	90,0	91,0	89,0	81,0	75,0	64,5
16,0	86,5	84,0	85,0	83,0	78,0	72,0	62,5
18,0	76,5	77,0	76,5	74,5	71,5	67,0	58,0
20,0	68,5	69,0	68,5	68,0	66,5	62,0	54,5
22,0	61,0	61,5	61,5	61,0	60,5	57,5	51,0
24,0	55,0	55,5	55,0	55,0	54,5	53,5	48,0
26,0	50,0	50,5	50,0	49,5	49,5	48,5	45,0
28,0	45,5	46,0	45,5	45,5	45,0	44,0	42,5
30,0	41,5	42,0	42,0	41,5	41,0	40,5	40,0
32,0	-	39,0	38,5	38,0	37,5	37,0	37,0
34,0	-	30,5	35,5	35,0	34,5	34,0	34,0
36,0	-	-	28,0	32,5	32,0	31,5	31,5
38,0	-	-	-	30,5	30,0	29,0	29,0
40,0	-	-	-	25,0	27,5	26,5	26,5
42,0	-	-	-	-	25,5	24,5	24,5
44,0	-	-	-	-	22,0	22,5	22,5
46,0	-	-	-	-	-	21,0	21,0
48,0	-	-	-	-	-	19,1	19,3
50,0	-	-	-	-	-	14,4	17,9
52,0	-	-	-	-	-	-	16,5
54,0	-	-	-	-	-	-	14,2



35,3 – 60,0 m



8,9 m



360°



140 t



EN 13000

m	35,3	38,0	40,2	45,0	49,8	54,6	60,0
5,0	166,0	-	-	-	-	-	-
6,0	160,0	123,0	150,0	-	-	-	-
7,0	152,0	118,0	145,0	140,0	-	-	-
8,0	144,0	114,0	137,0	131,0	105,0	-	-
9,0	136,0	110,0	128,0	123,0	101,0	97,5	-
10,0	128,0	106,0	121,0	115,0	98,0	93,5	78,0
11,0	118,0	103,0	115,0	109,0	94,5	89,5	75,0
12,0	109,0	100,0	108,0	104,0	91,0	85,0	72,0
13,0	103,0	97,0	102,0	99,0	88,0	82,0	69,5
14,0	96,0	94,0	95,0	93,0	85,5	78,5	67,0
15,0	90,0	87,5	88,5	86,5	82,5	75,0	64,5
16,0	84,0	84,0	84,0	81,0	80,0	72,0	62,5
18,0	73,5	74,0	73,5	73,0	71,5	67,0	58,0
20,0	65,0	65,5	65,0	65,0	64,5	62,0	54,5
22,0	58,0	58,5	58,5	58,0	57,5	57,0	51,0
24,0	52,5	53,0	52,5	52,0	51,5	51,0	48,0
26,0	47,5	48,0	47,5	47,0	46,5	46,0	45,0
28,0	43,5	43,5	43,5	43,0	42,5	41,5	42,0
30,0	39,5	40,0	39,5	39,0	38,5	37,5	38,0
32,0	-	36,0	35,5	35,0	34,5	34,0	34,0
34,0	-	30,5	32,5	32,0	31,5	30,5	31,0
36,0	-	-	28,0	29,0	28,5	27,5	28,0
38,0	-	-	-	26,5	26,0	25,0	25,5
40,0	-	-	-	24,5	24,0	23,0	23,0
42,0	-	-	-	-	22,0	21,0	21,0
44,0	-	-	-	-	20,0	19,2	19,4
46,0	-	-	-	-	-	17,6	17,7
48,0	-	-	-	-	-	16,2	16,3
50,0	-	-	-	-	-	14,4	15,0
52,0	-	-	-	-	-	-	13,7
54,0	-	-	-	-	-	-	12,7

Load charts • Traglasten • Capacités de levage Capacidades • Capacità • Таблицы грузоподъемности

Mega-Wing-Lift

Telescopic boom • Teleskopausleger • Flèche principale • Pluma telescópica • Braccio telescopico • Телескопическая стрела



35,3 – 60,0 m



8,9 m



360°



120 t



EN 13000

m	35,3	38,0	40,2	45,0	49,8	54,6	60,0
5,0	166,0	-	-	-	-	-	-
6,0	160,0	123,0	150,0	-	-	-	-
7,0	152,0	118,0	145,0	140,0	-	-	-
8,0	144,0	114,0	137,0	131,0	105,0	-	-
9,0	136,0	110,0	128,0	123,0	101,0	97,5	-
10,0	125,0	106,0	121,0	115,0	98,0	93,5	78,0
11,0	115,0	103,0	114,0	109,0	94,5	89,5	75,0
12,0	108,0	100,0	107,0	104,0	91,0	85,0	72,0
13,0	100,0	97,0	99,0	97,0	88,0	82,0	69,5
14,0	92,5	90,0	91,5	89,5	85,5	78,5	67,0
15,0	85,5	86,0	85,5	85,0	82,5	75,0	64,5
16,0	79,5	80,0	79,5	79,0	78,0	72,0	62,5
18,0	69,5	70,0	69,5	69,5	69,0	67,0	58,0
20,0	61,5	62,0	61,5	61,0	61,0	60,0	54,5
22,0	54,5	55,0	54,5	54,0	53,5	53,0	51,0
24,0	48,0	48,5	48,0	48,0	47,0	46,5	46,5
26,0	42,5	43,0	42,5	42,0	41,5	41,0	41,0
28,0	38,0	38,5	38,0	37,5	37,0	36,0	36,5
30,0	34,0	34,5	34,0	33,5	33,0	32,0	32,5
32,0	-	31,0	30,5	30,0	29,5	29,0	29,0
34,0	-	28,0	27,5	27,0	26,5	26,0	26,0
36,0	-	-	25,0	24,5	24,0	23,5	23,5
38,0	-	-	-	22,5	22,0	21,0	21,0
40,0	-	-	-	20,5	19,8	19,0	19,2
42,0	-	-	-	-	18,1	17,2	17,4
44,0	-	-	-	-	16,5	15,6	15,8
46,0	-	-	-	-	-	14,2	14,3
48,0	-	-	-	-	-	12,9	13,0
50,0	-	-	-	-	-	11,8	11,8
52,0	-	-	-	-	-	-	10,7
54,0	-	-	-	-	-	-	9,7



35,3 – 60,0 m



8,9 m



360°



100 t



EN 13000

m	35,3	38,0	40,2	45,0	49,8	54,6	60,0
5,0	166,0	-	-	-	-	-	-
6,0	160,0	123,0	150,0	-	-	-	-
7,0	152,0	118,0	145,0	140,0	-	-	-
8,0	144,0	114,0	137,0	131,0	105,0	-	-
9,0	134,0	110,0	128,0	123,0	101,0	97,5	-
10,0	122,0	106,0	121,0	115,0	98,0	93,5	78,0
11,0	111,0	103,0	112,0	109,0	94,5	89,5	75,0
12,0	103,0	100,0	102,0	100,0	91,0	85,0	72,0
13,0	94,5	92,5	94,0	93,5	88,0	82,0	69,5
14,0	87,5	87,5	87,5	87,0	84,0	78,5	67,0
15,0	81,0	81,5	81,0	80,5	78,5	75,0	64,5
16,0	75,0	75,5	75,0	74,5	72,5	69,5	62,5
18,0	64,5	65,0	64,5	64,0	62,5	60,0	58,0
20,0	55,0	55,5	55,0	54,5	54,0	52,5	51,0
22,0	47,0	47,5	47,5	47,0	46,0	45,5	45,0
24,0	41,0	41,5	41,0	40,5	40,0	39,5	39,5
26,0	36,0	36,5	36,0	35,5	35,0	34,5	34,5
28,0	32,0	32,5	32,0	31,5	31,0	30,0	30,5
30,0	28,5	29,0	28,5	28,0	27,5	26,5	27,0
32,0	-	26,0	25,5	25,0	24,5	23,5	24,0
34,0	-	23,0	23,0	22,5	21,5	21,0	21,0
36,0	-	-	20,5	20,0	19,4	18,6	18,8
38,0	-	-	-	18,0	17,4	16,5	16,7
40,0	-	-	-	16,2	15,6	14,7	14,9
42,0	-	-	-	-	14,0	13,1	13,3
44,0	-	-	-	-	12,6	11,7	11,9
46,0	-	-	-	-	-	10,5	10,6
48,0	-	-	-	-	-	9,3	9,4
50,0	-	-	-	-	-	8,3	8,4
52,0	-	-	-	-	-	-	7,4
54,0	-	-	-	-	-	-	6,6

Load charts • Traglasten • Capacités de levage Capacidades • Capacità • Таблицы грузоподъемности

Lattice extension • Auslegerverlängerung • Extension treillis • Plumín fijo • Jib • Стрела крана



16,0 – 54,6 m



3°, 25°
12,0 - 70,0 m



8,9 m



360°

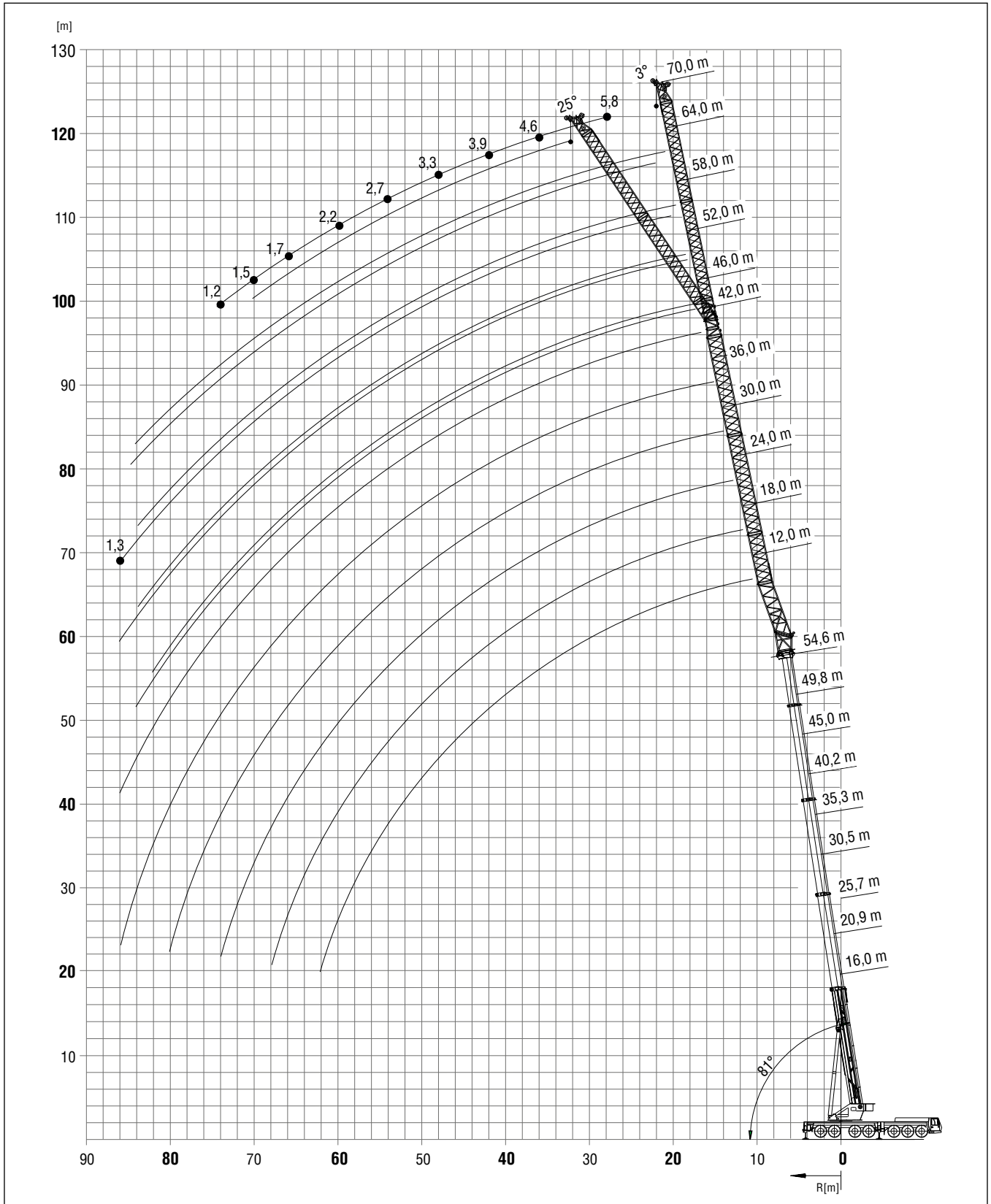

Load charts • Traglasten • Capacités de levage Capacidades • Capacità • Таблицы грузоподъемности

Lattice extension • Auslegerverlängerung • Extension treillis • Plumín fijo • Jib • Стрела крана



49,8 - 54,6 m



3°, 25°
12 - 70 m



8,9 m



360°



120 t



EN 13000

m m	49,8																
	12 3°	18 3°	24 3°	30 3°	36 3°	42 3°	46		52		58		64		70		
							3°	25°	3°	25°	3°	25°	3°	25°	3°	25°	
13,0	46,0	-	-	-	-	-	-	-	-	-	-	-	-	-	-	-	-
14,0	45,0	38,5	-	-	-	-	-	-	-	-	-	-	-	-	-	-	-
15,0	43,5	37,5	-	-	-	-	-	-	-	-	-	-	-	-	-	-	-
16,0	42,5	36,5	29,0	-	-	-	-	-	-	-	-	-	-	-	-	-	-
18,0	39,5	35,0	27,5	22,0	-	-	-	-	-	-	-	-	-	-	-	-	-
20,0	36,5	33,0	26,0	21,0	18,6	-	-	-	-	-	-	-	-	-	-	-	-
22,0	33,5	30,5	24,5	20,0	17,7	14,9	12,4	-	-	-	-	-	-	-	-	-	-
24,0	30,5	28,0	23,5	19,0	16,8	14,2	11,8	11,1	10,2	-	-	-	-	-	-	-	-
26,0	28,5	26,0	22,0	18,1	16,0	13,5	11,2	10,6	9,7	-	8,5	-	-	-	-	-	-
28,0	26,0	24,0	21,0	17,2	15,3	12,7	10,6	10,0	9,2	8,2	8,1	-	6,8	-	5,8	-	5,8
30,0	23,5	22,5	20,5	16,5	14,6	11,8	10,0	9,5	8,7	7,8	7,6	6,5	6,5	-	5,5	-	5,5
32,0	22,5	21,0	19,4	15,8	13,9	11,1	9,5	9,0	8,3	7,4	7,2	6,2	6,1	-	5,2	-	5,2
34,0	21,0	19,8	18,4	15,1	13,3	10,7	9,0	8,6	7,8	7,0	6,8	5,9	5,8	-	4,9	-	4,9
36,0	19,3	18,4	17,4	14,4	12,7	10,2	8,6	8,2	7,4	6,7	6,5	5,6	5,5	4,6	4,6	-	4,6
38,0	17,8	17,2	16,4	13,7	12,0	9,7	8,2	7,8	7,1	6,4	6,1	5,3	5,2	4,3	4,4	-	4,4
40,0	16,5	16,2	15,4	13,0	11,3	9,4	7,8	7,4	6,7	6,0	5,8	5,0	5,0	4,1	4,1	4,1	3,3
42,0	15,4	15,1	14,4	12,3	10,6	9,0	7,4	7,1	6,3	5,8	5,5	4,8	4,7	3,8	3,9	3,9	3,1
44,0	14,2	14,1	13,4	11,6	10,2	8,6	7,1	6,8	6,0	5,5	5,2	4,5	4,4	3,6	3,7	3,7	2,9
46,0	13,1	13,1	12,4	11,1	9,9	8,3	6,8	6,5	5,8	5,2	4,9	4,3	4,1	3,4	3,5	3,5	2,7
48,0	12,0	12,2	11,4	10,6	9,5	8,0	6,5	6,2	5,5	5,0	4,7	4,1	3,9	3,2	3,3	3,3	2,5
50,0	11,1	11,3	10,6	10,1	9,1	7,7	6,2	5,9	5,2	4,8	4,4	3,9	3,7	3,0	3,1	3,1	2,4
52,0	10,1	10,4	10,0	9,5	8,8	7,4	5,9	5,7	4,9	4,5	4,2	3,7	3,5	2,9	2,9	2,9	2,2
54,0	9,1	9,6	9,5	9,0	8,4	7,1	5,7	5,5	4,7	4,3	4,0	3,5	3,3	2,7	2,7	2,7	2,1
56,0	8,1	8,8	8,9	8,5	8,1	6,8	5,4	5,2	4,5	4,1	3,8	3,3	3,1	2,5	2,5	2,5	1,9
58,0	7,3	8,0	8,3	8,0	7,7	6,6	5,2	5,0	4,3	4,0	3,6	3,1	2,9	2,4	2,3	2,3	1,8
60,0	-	7,1	7,7	7,5	7,3	6,4	5,0	4,8	4,1	3,8	3,4	3,0	2,7	2,2	2,2	2,2	1,6
62,0	-	6,4	7,1	7,1	6,9	6,2	4,8	4,6	3,9	3,6	3,2	2,8	2,6	2,1	2,0	2,0	1,5
66,0	-	-	5,7	6,1	6,1	5,7	4,4	4,3	3,6	3,3	2,9	2,6	2,3	1,9	1,7	1,7	1,3
70,0	-	-	4,4	4,8	5,2	5,0	3,9	3,8	3,2	3,0	2,6	2,3	2,0	1,6	1,5	1,5	1,1
74,0	-	-	-	3,6	4,0	4,1	3,2	3,4	2,9	2,6	2,4	2,1	1,7	1,4	1,2	-	-
78,0	-	-	-	-	2,9	3,1	2,2	2,3	2,5	2,7	2,1	1,9	1,5	1,2	-	-	-
82,0	-	-	-	-	-	2,1	1,2	1,3	1,5	1,5	1,8	1,6	1,3	1,0	-	-	-
86,0	-	-	-	-	-	1,2	-	-	-	1,9	-	1,3	-	-	-	-	-

m m	54,6																
	12 3°	18 3°	24 3°	30 3°	36 3°	42 3°	46		52		58		64		70		
							3°	25°	3°	25°	3°	25°	3°	25°	3°	25°	
14,0	38,5	-	-	-	-	-	-	-	-	-	-	-	-	-	-	-	-
15,0	37,5	34,0	-	-	-	-	-	-	-	-	-	-	-	-	-	-	-
16,0	36,5	33,0	-	-	-	-	-	-	-	-	-	-	-	-	-	-	-
18,0	34,5	31,5	26,0	-	-	-	-	-	-	-	-	-	-	-	-	-	-
20,0	33,0	29,0	25,0	21,0	-	-	-	-	-	-	-	-	-	-	-	-	-
22,0	30,5	27,5	24,0	20,0	17,0	-	-	-	-	-	-	-	-	-	-	-	-
24,0	28,5	25,5	22,5	19,3	16,3	13,7	11,3	10,7	-	-	-	-	-	-	-	-	-
26,0	26,0	23,5	21,5	18,5	15,6	12,8	10,8	10,2	9,3	-	-	-	-	-	-	-	-
28,0	24,0	22,0	20,0	17,7	15,0	11,9	10,3	9,8	8,9	-	7,6	-	-	-	-	-	-
30,0	22,5	21,0	19,0	16,9	14,3	11,5	9,8	9,3	8,4	7,6	7,3	-	6,1	-	5,0	-	-
32,0	21,0	19,4	18,0	16,1	13,6	11,0	9,4	8,9	8,0	7,3	6,9	6,0	5,8	-	4,8	-	-
34,0	19,7	18,3	16,9	15,3	12,9	10,5	8,9	8,5	7,7	6,9	6,7	5,7	5,5	-	4,6	-	-
36,0	18,3	17,2	16,0	14,6	12,1	10,1	8,5	8,1	7,3	6,6	6,3	5,5	5,3	-	4,3	-	-
38,0	17,2	16,1	15,2	13,8	11,5	9,7	8,2	7,8	7,0	6,3	6,0	5,2	5,0	4,2	4,1	-	-
40,0	16,1	15,1	14,3	13,1	11,1	9,3	7,8	7,4	6,6	6,0	5,7	4,9	4,8	4,0	3,9	-	-
42,0	15,0	14,1	13,5	12,3	10,6	9,0	7,4	7,1	6,3	5,7	5,5	4,7	4,6	3,8	3,7	3,0	-
44,0	13,9	13,1	12,7	11,5	10,1	8,7	7,1	6,8	6,0	5,5	5,2	4,5	4,3	3,6	3,5	2,8	-
46,0	13,0	12,1	12,0	10,8	9,7	8,3	6,8	6,5	5,8	5,2	4,9	4,3	4,1	3,4	3,3	2,6	-
48,0	12,1	11,0	11,2	10,0	9,2	8,0	6,5	6,3	5,5	5,0	4,7	4,1	3,9	3,2	3,2	2,5	-
50,0	11,2	10,4	10,4	9,4	8,7	7,7	6,2	6,0	5,3	4,8	4,5	3,9	3,7	3,0	3,0	2,3	-
52,0	10,2	9,8	9,6	8,9	8,3	7,4	6,0	5,8	5,0	4,6	4,2	3,7	3,5	2,9	2,8	2,2	-
54,0	9,3	9,2	9,0	8,5	7,9	7,0	5,7	5,5	4,8	4,4	4,0	3,5	3,3	2,7	2,7	2,0	-
56,0	8,7	8,6	8,5	8,0	7,5	6,7	5,5	5,3	4,6	4,2	3,9	3,4	3,1	2,5	2,5	1,9	-
58,0	7,8	8,0	8,0	7,5	7,1	6,4	5,2	5,1	4,4	4,0	3,7	3,2	2,9	2,4	2,3	1,8	-
60,0	7,0	7,4	7,5	7,1	6,7	6,1	4,9	4,9	4,2	3,9	3,5	3,0	2,8	2,3	2,2	1,6	-
62,0	6,3	6,7	7,0	6,7	6,4	5,8	4,7	4,6	4,0	3,7	3,3	2,9	2,6	2,1	2,0	1,5	-
66,0	-	5,3	5,9	5,9	5,7	5,2	4,1	4,1	3,6	3,4	3,0	2,6	2,3	1,9	1,8	1,3	-
70,0	-	-	4,6	4,9	5,0	4,6	3,6	3,6	3,2	3,0	2,7	2,4	2,1	1,7	1,5	1,1	-
74,0	-	-	3,5	3,8	4,1	4,0	3,1	3,2	2,7	2,7	2,4	2,2	1,8	1,5	1,3	-	-
78,0	-	-	-	2,7	3,0	3,1	2,2	2,4	2,3	2,4	2,0	1,9	1,5	1,3	1,1	-	-
82,0	-	-	-	-	2,1	2,1	1,2	1,4	1,5	1,9	1,7	1,7	1,2	1,1	-	-	-
86,0	-	-	-	-	1,2	1,3	-	-	-	-	-	1,4	-	-	-	-	-

Load charts • Traglasten • Capacités de levage Capacidades • Capacità • Таблицы грузоподъемности

Mega-Wing-Lift

Lattice extension • Auslegerverlängerung • Extension treillis • Plumín fijo • Jib • удлинитель стрелы



16,0 – 54,6 m



3°
12,0 - 24,0 m



8,9 m



360°

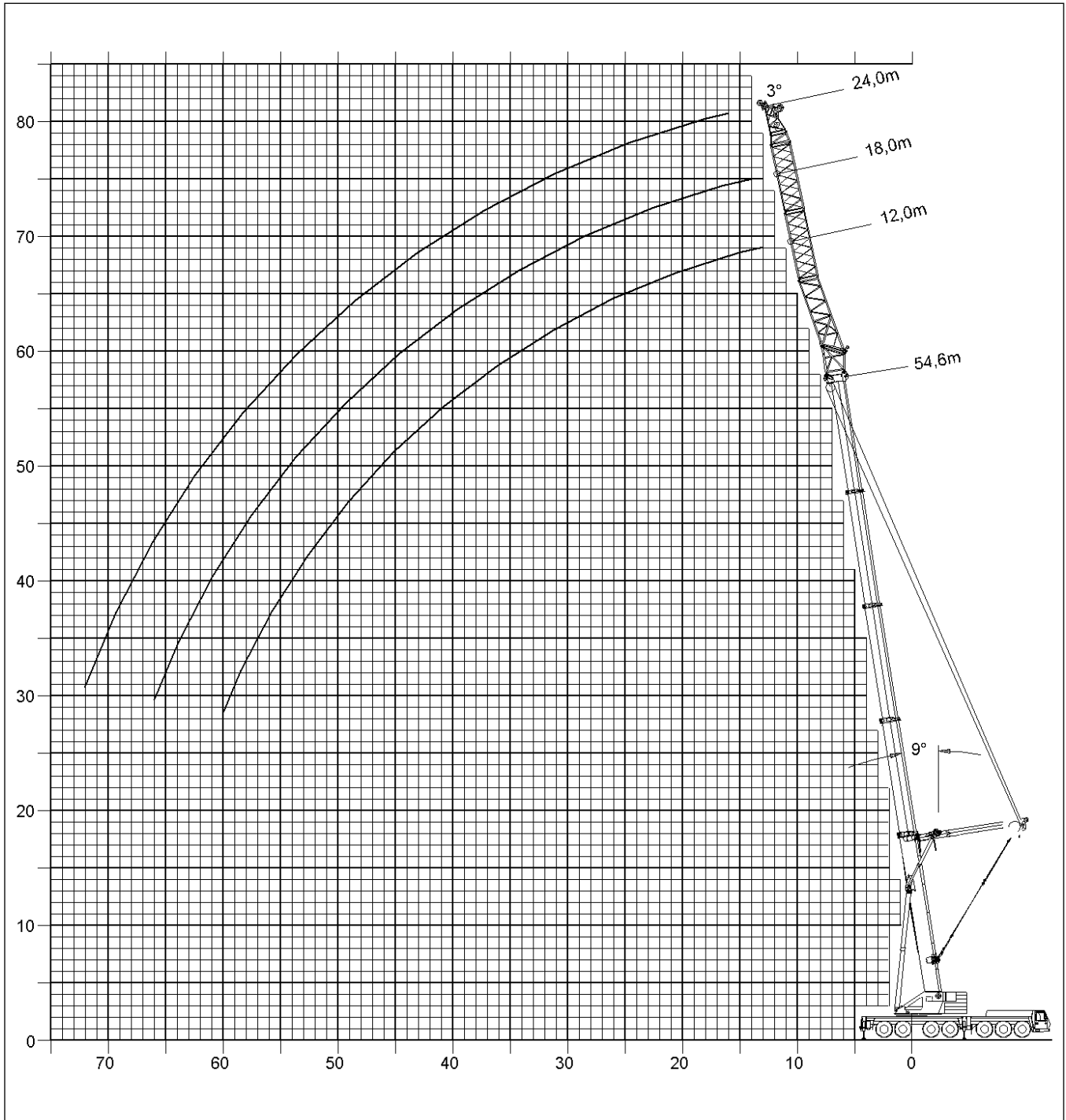

Load charts • Traglasten • Capacités de levage Capacidades • Capacità • Таблицы грузоподъемности

Mega-Wing-Lift

Lattice extension • Auslegerverlängerung • Extension treillis • Plumín fijo • Jib • удлинитель стрелы



49,8 - 54,6 m



3°
12 - 24 m



8,9 m



360°



160 t



EN 13000

m	49,8			54,6		
	12	18	24	12	18	24
m 3°	3°	3°	3°	3°	3°	3°
12,0	52,5	-	-	-	-	-
13,0	50,0	40,0	-	46,5	-	-
14,0	47,5	38,5	31,0	44,5	37,0	-
15,0	46,0	37,0	30,0	44,3	36,0	-
16,0	44,0	36,0	29,0	41,0	34,5	28,5
18,0	41,0	33,0	27,5	38,0	32,0	27,0
20,0	38,0	31,0	26,0	35,5	29,5	25,0
22,0	36,0	29,0	24,5	33,0	27,5	23,0
24,0	33,5	27,0	22,5	31,0	25,0	22,0
26,0	31,5	25,5	21,5	29,0	23,5	20,5
28,0	30,0	23,5	20,0	27,5	22,5	19,3
30,0	28,5	22,5	19,0	26,0	21,0	18,3
32,0	27,0	21,5	17,9	24,5	19,8	17,3
34,0	25,5	20,5	17,1	23,0	19,0	16,4
36,0	24,5	19,2	16,3	22,0	18,1	15,5
38,0	23,0	18,3	15,5	20,5	17,2	14,6
40,0	22,0	17,6	14,7	19,9	16,4	13,8
42,0	21,0	16,9	14,0	19,1	15,6	13,0
44,0	20,5	16,1	13,3	18,3	14,8	12,1
46,0	19,5	15,4	12,6	17,5	14,0	11,6
48,0	17,9	14,9	12,0	16,9	13,3	11,2
50,0	16,4	14,3	11,3	16,3	12,5	10,7
52,0	15,0	13,8	10,8	15,5	12,0	10,3
54,0	13,7	13,3	10,4	14,2	11,6	9,8
56,0	12,2	12,8	10,0	13,0	11,2	9,5
58,0	-	12,2	9,7	11,9	10,8	9,2
60,0	-	11,2	9,3	10,9	10,5	8,8
62,0	-	9,7	-	-	10,2	-
66,0	-	-	-	-	8,8	-

Load charts • Traglasten • Capacités de levage Capacidades • Capacità • Таблицы грузоподъемности

Luffing jib • Wippspitzenausleger • Volée variable • Plumín de angulación variable • Jib a volata variable • Маневровый гусек



81° / 70° / 60°
16,0 - 54,6 m



2,9 + 25 - 73 m



8,9 m



360°

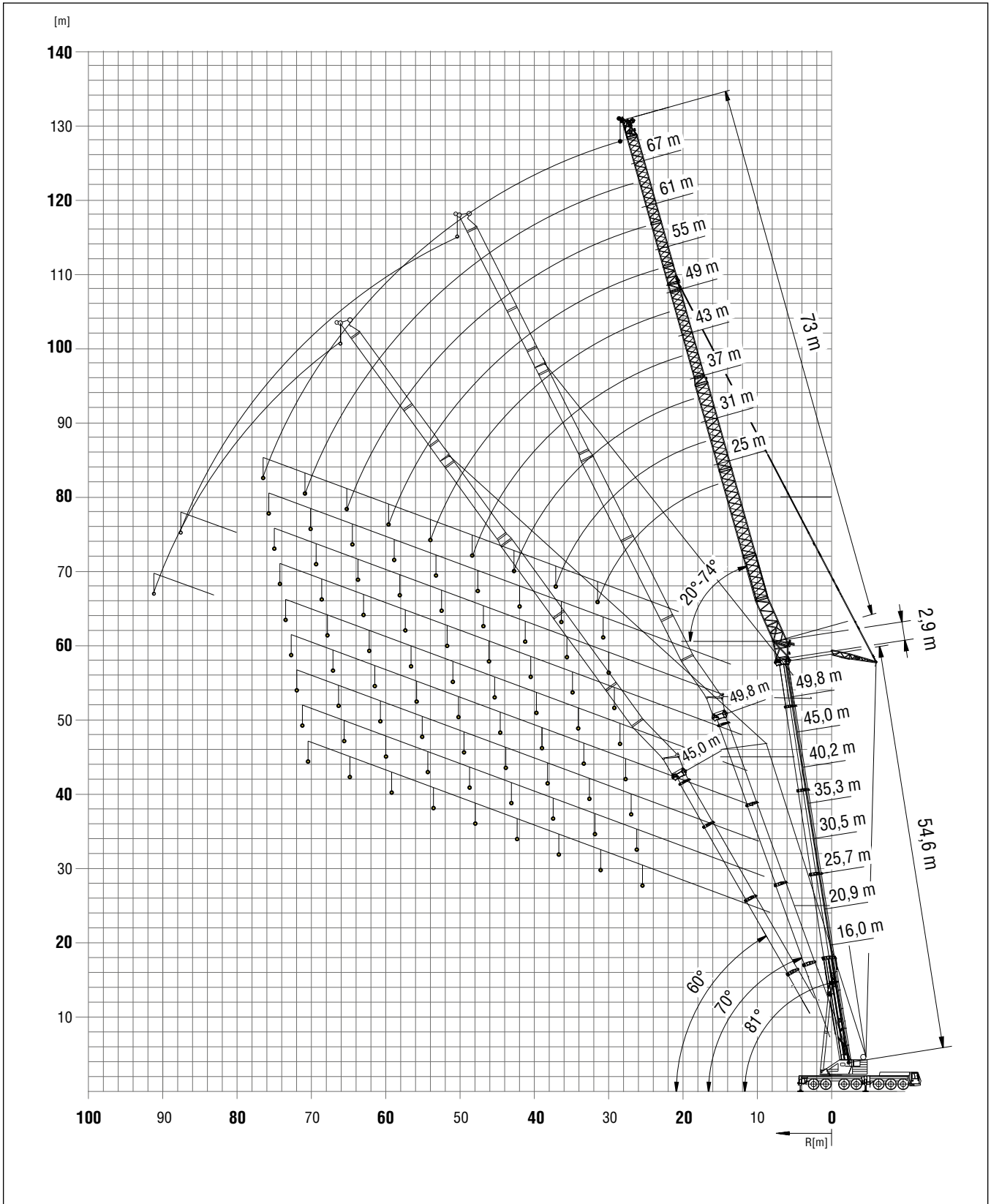

Load charts • Traglasten • Capacités de levage Capacidades • Capacità • Таблицы грузоподъемности

Luffing jib • Wippspitzenausleger • Volée variable • Plumín de angulación variable • Jib a volata variable • Маневровый гусек



81°
16,0 + 2,9 m



25 - 73 m
0° / 22°*



8,9 m



360°



120 t



EN 13000

m m	16,0 + 2,9													
	25 0°	31 0°	37 0°	43 0°	49 0°	55		61		67		73		
	0°	0°	0°	0°	0°	0°	22°	0°	22°	0°	22°	0°	22°	
11,0	80,0	-	-	-	-	-	-	-	-	-	-	-	-	
12,0	77,5	65,5	-	-	-	-	-	-	-	-	-	-	-	
13,0	74,5	64,0	-	-	-	-	-	-	-	-	-	-	-	
14,0	72,0	63,0	52,5	-	-	-	-	-	-	-	-	-	-	
15,0	69,0	62,0	51,5	42,0	-	-	-	-	-	-	-	-	-	
16,0	66,0	61,0	51,0	41,5	-	-	-	-	-	-	-	-	-	
18,0	61,0	58,5	49,5	40,5	33,5	-	-	-	-	-	-	-	-	
20,0	57,5	56,5	48,0	39,5	32,5	26,0	26,0	19,7	-	-	-	-	-	
22,0	50,5	54,5	46,5	38,5	31,5	25,0	25,0	19,1	-	15,0	-	-	-	
24,0	41,0	50,0	45,5	38,0	30,5	24,0	24,5	18,4	18,5	14,5	10,7	10,7	-	
26,0	31,0	43,5	43,5	37,0	29,5	23,5	23,5	17,7	17,9	13,9	10,3	10,3	-	
28,0	-	37,0	42,0	36,0	28,5	22,5	22,5	17,2	17,3	13,4	12,6	9,9	-	
30,0	-	31,0	37,5	34,5	28,0	21,5	21,5	16,6	16,7	12,9	12,2	9,5	-	
32,0	-	24,0	33,0	33,5	27,0	21,0	21,0	16,0	16,2	12,3	11,8	9,1	8,0	
34,0	-	-	28,5	32,0	26,0	20,0	20,0	15,4	15,6	11,7	11,5	8,7	7,8	
36,0	-	-	24,5	29,0	25,5	19,5	19,5	14,9	15,1	11,1	10,8	8,4	7,5	
38,0	-	-	19,4	26,0	24,5	18,9	18,9	14,4	14,6	10,5	10,2	8,0	7,3	
40,0	-	-	-	22,5	24,0	18,3	18,3	14,0	14,1	10,2	9,6	7,7	7,1	
42,0	-	-	-	19,4	22,0	17,8	17,8	13,5	13,6	9,8	9,4	7,4	6,9	
44,0	-	-	-	-	19,8	17,2	17,3	12,9	13,2	9,5	9,2	7,0	6,7	
46,0	-	-	-	-	17,7	16,7	16,8	12,4	12,7	9,1	9,0	6,8	6,6	
48,0	-	-	-	-	15,6	16,2	16,3	11,9	12,3	8,8	8,8	6,5	6,4	
50,0	-	-	-	-	-	15,3	15,8	11,3	11,8	8,5	8,5	6,2	6,2	
52,0	-	-	-	-	-	14,4	15,0	11,0	11,3	8,2	8,3	6,0	6,1	
54,0	-	-	-	-	-	12,8	-	10,7	10,9	7,9	8,0	5,7	5,9	
56,0	-	-	-	-	-	-	-	10,4	10,4	7,7	7,8	5,5	5,6	
58,0	-	-	-	-	-	-	-	10,0	-	7,4	7,5	5,3	5,4	
60,0	-	-	-	-	-	-	-	9,7	-	7,1	7,2	5,1	5,2	
62,0	-	-	-	-	-	-	-	-	-	6,9	7,0	4,8	5,0	
64,0	-	-	-	-	-	-	-	-	-	6,7	6,7	4,6	4,8	
66,0	-	-	-	-	-	-	-	-	-	6,4	4,4	4,4	-	
68,0	-	-	-	-	-	-	-	-	-	-	4,2	4,2	-	
70,0	-	-	-	-	-	-	-	-	-	-	4,1	4,1	-	
72,0	-	-	-	-	-	-	-	-	-	-	3,9	3,9	-	

* Jib offset 22° after suspension point • 22° Abwinkelung oberhalb der Spitzenabspannung • Déport de flechette 22° après le point de suspension • Plumín articulado angularable 22° a partir 55m • Inclinazione del jib a 22° dopo il punto di cerniera

Load charts • Traglasten • Capacités de levage Capacidades • Capacità • Таблицы грузоподъемности

Luffing jib • Wippspitzenausleger • Volée variable • Plumín de angulación variable • Jib a volata variable • Маневровый гусек



81°
25,7 + 2,9 m



25 - 73 m
0° / 22°*



8,9 m



360°



120 t



EN 13000

m m	25,7 + 2,9																	
	25		31		37		43		49		55		61		67		73	
	0°	0°	0°	0°	0°	0°	0°	22°	0°	22°	0°	22°	0°	22°	0°	22°		
13,0	71,5	-	-	-	-	-	-	-	-	-	-	-	-	-	-	-	-	
14,0	69,0	57,0	-	-	-	-	-	-	-	-	-	-	-	-	-	-	-	
15,0	66,5	57,0	-	-	-	-	-	-	-	-	-	-	-	-	-	-	-	
16,0	64,0	56,0	45,5	-	-	-	-	-	-	-	-	-	-	-	-	-	-	
18,0	59,0	55,0	45,0	36,0	-	-	-	-	-	-	-	-	-	-	-	-	-	
20,0	55,0	53,5	44,5	36,0	29,0	-	-	-	-	-	-	-	-	-	-	-	-	
22,0	52,0	52,0	43,5	36,0	28,5	22,5	-	17,6	-	-	-	-	-	-	-	-	-	
24,0	49,0	50,5	42,5	35,0	28,0	21,5	22,0	17,1	-	13,5	-	-	-	-	-	-	-	
26,0	46,5	49,5	41,5	34,5	27,0	21,0	21,0	16,6	16,8	13,0	-	9,8	-	-	-	-	-	
28,0	35,0	47,0	41,0	34,0	26,5	20,5	20,5	16,1	16,3	12,4	-	9,4	-	-	-	-	-	
30,0	-	42,0	40,0	33,0	26,0	20,0	20,0	15,6	15,8	11,9	12,2	9,1	-	-	-	-	-	
32,0	-	36,0	39,0	32,5	25,0	19,6	19,6	15,2	15,4	11,3	11,5	8,8	-	-	-	-	-	
34,0	-	27,5	36,0	32,0	24,5	19,0	19,1	14,8	14,9	11,0	10,8	8,4	7,8	-	-	-	-	
36,0	-	-	32,5	31,5	24,0	18,5	18,6	14,3	14,5	10,6	10,1	8,1	7,6	-	-	-	-	
38,0	-	-	28,5	31,0	23,5	18,0	18,1	13,9	14,0	10,3	9,9	7,8	7,4	-	-	-	-	
40,0	-	-	-	28,5	22,5	17,6	17,6	13,5	13,6	9,9	9,6	7,5	7,2	-	-	-	-	
42,0	-	-	-	26,0	21,5	17,1	17,1	13,1	13,2	9,6	9,4	7,2	7,0	-	-	-	-	
44,0	-	-	-	23,0	20,5	16,6	16,7	12,7	12,8	9,3	9,2	6,9	6,8	-	-	-	-	
46,0	-	-	-	-	19,7	16,2	16,2	12,3	12,3	9,0	9,0	6,7	6,6	-	-	-	-	
48,0	-	-	-	-	18,8	15,8	15,8	11,8	11,7	8,7	8,8	6,4	6,4	-	-	-	-	
50,0	-	-	-	-	17,9	15,3	15,4	11,4	11,2	8,4	8,5	6,2	6,3	-	-	-	-	
52,0	-	-	-	-	-	15,0	15,0	10,9	10,9	8,1	8,3	5,9	6,1	-	-	-	-	
54,0	-	-	-	-	-	14,6	14,6	10,5	10,6	7,9	8,0	5,7	5,9	-	-	-	-	
56,0	-	-	-	-	-	14,2	-	10,2	10,3	7,6	7,7	5,4	5,7	-	-	-	-	
58,0	-	-	-	-	-	-	-	9,9	10,0	7,3	7,5	5,2	5,4	-	-	-	-	
60,0	-	-	-	-	-	-	-	9,6	9,7	7,1	7,2	5,0	5,2	-	-	-	-	
62,0	-	-	-	-	-	-	-	9,4	-	6,9	7,0	4,8	5,0	-	-	-	-	
64,0	-	-	-	-	-	-	-	-	-	6,6	6,7	4,6	4,8	-	-	-	-	
66,0	-	-	-	-	-	-	-	-	-	6,4	6,5	4,4	4,6	-	-	-	-	
68,0	-	-	-	-	-	-	-	-	-	6,2	-	4,2	4,4	-	-	-	-	
70,0	-	-	-	-	-	-	-	-	-	-	-	4,1	4,2	-	-	-	-	
72,0	-	-	-	-	-	-	-	-	-	-	-	3,9	4,0	-	-	-	-	

Load charts • Traglasten • Capacités de levage Capacidades • Capacità • Таблицы грузоподъемности

Luffing jib • Wippspitzenausleger • Volée variable • Plumín de angulación variable • Jib a volata variable • Маневровый гусек



81°
35,3 + 2,9 m



25 - 73 m
0° / 22°*



8,9 m



360°



120 t



EN 13000

m m	35,3 + 2,9													
	25 0°	31 0°	37 0°	43 0°	49 0°	55 0° 22°		61 0° 22°		67 0° 22°		73 0° 22°		
15,0	52,5	-	-	-	-	-	-	-	-	-	-	-	-	-
16,0	52,5	45,0	-	-	-	-	-	-	-	-	-	-	-	-
18,0	49,0	45,0	36,5	-	-	-	-	-	-	-	-	-	-	-
20,0	46,0	43,0	36,5	29,5	-	-	-	-	-	-	-	-	-	-
22,0	43,5	41,0	36,5	29,5	23,0	-	-	-	-	-	-	-	-	-
24,0	40,5	38,5	35,0	29,0	23,0	18,4	-	14,5	-	-	-	-	-	-
26,0	38,5	36,5	34,0	29,0	22,5	18,0	18,1	14,4	-	10,8	-	-	-	-
28,0	36,5	34,5	32,5	28,5	22,0	17,7	17,8	14,1	-	10,8	-	8,3	-	-
30,0	34,5	33,0	31,0	28,0	22,0	17,4	17,5	13,8	13,9	10,5	-	8,2	-	-
32,0	-	31,0	29,5	27,0	21,5	17,1	17,1	13,4	13,6	10,2	-	7,9	-	-
34,0	-	30,0	28,0	26,0	21,0	16,8	16,8	13,1	13,3	10,0	10,2	7,7	-	-
36,0	-	28,5	27,0	25,0	20,5	16,4	16,5	12,9	13,0	9,7	9,9	7,4	7,6	-
38,0	-	-	26,0	24,0	20,5	16,1	16,2	12,6	12,7	9,4	9,6	7,2	7,4	-
40,0	-	-	25,0	23,0	20,0	15,8	15,8	12,2	12,4	9,2	9,4	7,0	7,1	-
42,0	-	-	-	22,5	19,6	15,5	15,5	11,9	12,1	8,9	9,1	6,7	6,9	-
44,0	-	-	-	21,5	19,3	15,2	15,2	11,5	11,7	8,7	8,9	6,5	6,7	-
46,0	-	-	-	21,0	18,9	14,8	14,9	11,1	11,3	8,4	8,6	6,3	6,5	-
48,0	-	-	-	-	18,6	14,5	14,6	10,8	10,9	8,2	8,4	6,1	6,3	-
50,0	-	-	-	-	18,2	14,2	14,3	10,5	10,6	8,0	8,1	5,8	6,1	-
52,0	-	-	-	-	17,9	13,9	13,9	10,2	10,3	7,7	7,9	5,6	5,9	-
54,0	-	-	-	-	-	13,6	13,6	10,0	10,1	7,5	7,6	5,4	5,7	-
56,0	-	-	-	-	-	13,3	13,3	9,7	9,8	7,3	7,4	5,2	5,4	-
58,0	-	-	-	-	-	13,0	-	9,5	9,5	7,1	7,2	5,0	5,2	-
60,0	-	-	-	-	-	-	-	9,2	9,3	6,8	6,9	4,8	5,0	-
62,0	-	-	-	-	-	-	-	9,0	9,0	6,6	6,7	4,7	4,8	-
64,0	-	-	-	-	-	-	-	8,8	-	6,4	6,5	4,5	4,6	-
66,0	-	-	-	-	-	-	-	-	-	6,2	6,3	4,3	4,5	-
68,0	-	-	-	-	-	-	-	-	-	6,0	6,1	4,1	4,3	-
70,0	-	-	-	-	-	-	-	-	-	5,8	-	4,0	4,1	-
72,0	-	-	-	-	-	-	-	-	-	-	-	3,8	3,9	-
74,0	-	-	-	-	-	-	-	-	-	-	-	3,7	3,7	-



81°
45,0 + 2,9 m



25 - 73 m
0° / 22°*



8,9 m



360°



120 t



EN 13000

m m	45,0 + 2,9													
	25 0°	31 0°	37 0°	43 0°	49 0°	55 0° 22°		61 0° 22°		67 0° 22°		73 0° 22°		
18,0	39,0	-	-	-	-	-	-	-	-	-	-	-	-	-
20,0	37,5	32,0	-	-	-	-	-	-	-	-	-	-	-	-
22,0	35,0	31,0	26,0	20,5	-	-	-	-	-	-	-	-	-	-
24,0	32,5	29,5	26,0	20,5	16,9	-	-	-	-	-	-	-	-	-
26,0	30,5	28,5	25,5	20,5	16,9	13,5	-	10,5	-	-	-	-	-	-
28,0	28,5	27,0	25,0	20,5	16,8	13,5	13,5	10,5	-	8,2	-	-	-	-
30,0	27,0	25,5	24,0	20,5	16,7	13,4	13,4	10,5	-	8,2	-	6,2	-	-
32,0	25,5	24,5	23,0	20,5	16,5	13,3	13,3	10,4	10,4	8,2	-	6,2	-	-
34,0	-	23,0	22,0	20,5	16,4	13,1	13,1	10,2	10,3	8,1	-	6,2	-	-
36,0	-	22,5	21,0	19,5	16,3	13,0	13,0	10,1	10,2	7,9	8,0	6,0	-	-
38,0	-	21,5	20,0	18,7	16,1	12,8	12,9	9,9	10,0	7,8	7,9	5,9	6,0	-
40,0	-	-	19,4	18,0	16,0	12,7	12,7	9,8	9,9	7,6	7,7	5,8	5,9	-
42,0	-	-	18,6	17,3	15,8	12,5	12,6	9,6	9,7	7,5	7,6	5,6	5,8	-
44,0	-	-	17,8	16,6	15,4	12,4	12,4	9,5	9,6	7,3	7,4	5,5	5,7	-
46,0	-	-	-	15,9	15,0	12,2	12,2	9,3	9,4	7,2	7,3	5,3	5,5	-
48,0	-	-	-	15,4	14,6	12,1	12,1	9,2	9,2	7,0	7,1	5,2	5,4	-
50,0	-	-	-	-	14,1	11,8	11,9	9,0	9,1	6,9	7,0	5,0	5,2	-
52,0	-	-	-	-	13,6	11,6	11,7	8,8	8,9	6,7	6,8	4,9	5,1	-
54,0	-	-	-	-	13,1	11,4	11,4	8,7	8,7	6,6	6,7	4,8	4,9	-
56,0	-	-	-	-	-	11,2	11,2	8,5	8,6	6,4	6,5	4,6	4,8	-
58,0	-	-	-	-	-	11,0	11,0	8,4	8,4	6,3	6,4	4,5	4,6	-
60,0	-	-	-	-	-	10,9	-	8,2	8,2	6,1	6,2	4,3	4,5	-
62,0	-	-	-	-	-	-	-	8,0	8,1	6,0	6,0	4,2	4,3	-
64,0	-	-	-	-	-	-	-	7,9	7,9	5,8	5,9	4,0	4,2	-
66,0	-	-	-	-	-	-	-	7,7	-	5,7	5,7	3,9	4,0	-
68,0	-	-	-	-	-	-	-	-	-	5,5	5,6	3,8	3,9	-
70,0	-	-	-	-	-	-	-	-	-	5,4	5,4	3,6	3,8	-
72,0	-	-	-	-	-	-	-	-	-	5,2	-	3,5	3,6	-
74,0	-	-	-	-	-	-	-	-	-	-	-	3,4	3,5	-
76,0	-	-	-	-	-	-	-	-	-	-	-	3,3	3,3	-

Load charts • Traglasten • Capacités de levage Capacidades • Capacità • Таблицы грузоподъемности

Luffing jib • Wippspitzenausleger • Volée variable • Plumín de angulación variable • Jib a volata variable • Маневровый гусек



81°
49,8 + 2,9 m



25 - 73 m
0° / 22°



8,9 m



360°



120 t



EN 13000

m m	49,8 + 2,9													
	25 0°	31 0°	37 0°	43 0°	49 0°	55		61		67		73		
	0°	22°	0°	22°	0°	22°	0°	22°	0°	22°	0°	22°	0°	22°
20,0	30,5	-	-	-	-	-	-	-	-	-	-	-	-	-
22,0	30,0	26,0	-	-	-	-	-	-	-	-	-	-	-	-
24,0	28,5	26,0	20,5	16,8	-	-	-	-	-	-	-	-	-	-
26,0	27,0	25,0	20,5	16,8	13,2	-	-	-	-	-	-	-	-	-
28,0	25,5	23,5	20,5	16,8	13,2	10,8	-	8,7	-	-	-	-	-	-
30,0	24,0	23,0	20,5	16,8	13,2	10,8	10,7	8,7	-	6,6	-	-	-	-
32,0	23,0	22,0	20,0	16,8	13,2	10,7	10,7	8,7	8,5	6,6	-	4,9	-	-
34,0	-	21,0	19,4	16,8	13,2	10,6	10,7	8,6	8,5	6,6	-	4,9	-	-
36,0	-	19,9	18,6	16,7	13,2	10,6	10,6	8,5	8,4	6,5	-	4,9	-	-
38,0	-	19,0	17,9	16,2	13,2	10,5	10,5	8,4	8,3	6,4	6,5	4,8	-	-
40,0	-	-	17,1	15,7	13,2	10,4	10,4	8,3	8,2	6,3	6,4	4,7	4,8	-
42,0	-	-	16,4	15,1	13,2	10,3	10,3	8,2	8,1	6,2	6,3	4,6	4,8	-
44,0	-	-	15,8	14,5	13,0	10,2	10,2	8,1	8,0	6,1	6,2	4,5	4,7	-
46,0	-	-	-	13,9	12,7	10,1	10,2	8,0	7,9	6,0	6,1	4,4	4,6	-
48,0	-	-	-	13,4	12,5	10,0	10,1	7,9	7,8	5,9	6,0	4,3	4,5	-
50,0	-	-	-	12,9	12,3	9,9	10,0	7,8	7,7	5,8	5,9	4,2	4,4	-
52,0	-	-	-	-	11,9	9,8	9,9	7,7	7,6	5,7	5,8	4,1	4,3	-
54,0	-	-	-	-	11,4	9,7	9,8	7,6	7,5	5,7	5,7	4,0	4,2	-
56,0	-	-	-	-	11,0	9,6	9,7	7,5	7,4	5,6	5,6	3,9	4,1	-
58,0	-	-	-	-	-	9,5	9,5	7,4	7,3	5,4	5,5	3,8	4,0	-
60,0	-	-	-	-	-	9,3	9,4	7,3	7,2	5,3	5,4	3,7	3,9	-
62,0	-	-	-	-	-	9,2	-	7,2	7,1	5,2	5,3	3,6	3,8	-
64,0	-	-	-	-	-	-	-	7,0	7,0	5,1	5,2	3,5	3,7	-
66,0	-	-	-	-	-	-	-	6,9	6,9	5,0	5,1	3,4	3,5	-
68,0	-	-	-	-	-	-	-	6,8	-	4,9	5,0	3,3	3,4	-
70,0	-	-	-	-	-	-	-	-	-	4,8	4,8	3,2	3,3	-
72,0	-	-	-	-	-	-	-	-	-	4,7	4,7	3,1	3,2	-
74,0	-	-	-	-	-	-	-	-	-	4,6	-	3,0	3,1	-
76,0	-	-	-	-	-	-	-	-	-	-	-	2,9	3,0	-
78,0	-	-	-	-	-	-	-	-	-	-	-	2,8	2,9	-



81°
54,6 + 2,9 m



25 - 73 m
0° / 22°



8,9 m



360°



120 t



EN 13000

m m	54,6 + 2,9													
	25 0°	31 0°	37 0°	43 0°	49 0°	55		61		67		73		
	0°	22°	0°	22°	0°	22°	0°	22°	0°	22°	0°	22°	0°	22°
22,0	25,0	-	-	-	-	-	-	-	-	-	-	-	-	-
24,0	25,0	20,5	-	-	-	-	-	-	-	-	-	-	-	-
26,0	25,0	20,5	16,6	13,5	-	-	-	-	-	-	-	-	-	-
28,0	23,5	20,5	16,6	13,5	10,8	-	-	-	-	-	-	-	-	-
30,0	22,5	20,5	16,6	13,5	10,8	8,9	-	6,9	-	-	-	-	-	-
32,0	21,5	19,6	16,6	13,5	10,8	8,9	8,8	6,9	-	5,3	-	-	-	-
34,0	20,5	18,7	16,6	13,5	10,8	8,8	8,8	6,9	6,8	5,3	-	3,8	-	-
36,0	-	17,9	16,6	13,5	10,8	8,8	8,8	6,9	6,8	5,3	-	3,8	-	-
38,0	-	17,2	16,0	13,5	10,8	8,7	8,7	6,8	6,8	5,2	5,2	3,8	-	-
40,0	-	16,4	15,3	13,5	10,8	8,7	8,7	6,8	6,8	5,2	5,2	3,7	3,7	-
42,0	-	-	14,7	13,4	10,8	8,6	8,6	6,7	6,7	5,1	5,2	3,7	3,7	-
44,0	-	-	14,1	12,9	10,8	8,6	8,6	6,6	6,7	5,1	5,1	3,6	3,7	-
46,0	-	-	13,5	12,4	10,8	8,5	8,5	6,6	6,6	5,0	5,1	3,6	3,7	-
48,0	-	-	-	11,9	10,7	8,4	8,5	6,5	6,6	4,9	5,0	3,5	3,6	-
50,0	-	-	-	11,5	10,6	8,4	8,4	6,5	6,5	4,9	4,9	3,4	3,5	-
52,0	-	-	-	11,0	10,5	8,3	8,3	6,4	6,4	4,8	4,9	3,4	3,5	-
54,0	-	-	-	-	10,1	8,3	8,3	6,3	6,4	4,7	4,8	3,3	3,4	-
56,0	-	-	-	-	9,7	8,2	8,2	6,3	6,3	4,7	4,7	3,2	3,3	-
58,0	-	-	-	-	9,2	8,2	8,1	6,2	6,2	4,6	4,7	3,2	3,3	-
60,0	-	-	-	-	-	7,9	7,9	6,1	6,2	4,5	4,6	3,1	3,2	-
62,0	-	-	-	-	-	7,7	-	6,1	6,1	4,5	4,5	3,0	3,1	-
64,0	-	-	-	-	-	7,5	-	6,0	6,0	4,4	4,4	3,0	3,0	-
66,0	-	-	-	-	-	-	-	5,9	5,9	4,3	4,4	2,9	3,0	-
68,0	-	-	-	-	-	-	-	5,8	-	4,2	4,3	2,8	2,9	-
70,0	-	-	-	-	-	-	-	-	-	4,2	4,2	2,7	2,8	-
72,0	-	-	-	-	-	-	-	-	-	4,1	4,1	2,7	2,7	-
74,0	-	-	-	-	-	-	-	-	-	4,0	-	2,6	2,7	-
76,0	-	-	-	-	-	-	-	-	-	-	-	2,5	2,6	-
78,0	-	-	-	-	-	-	-	-	-	-	-	2,4	2,5	-
80,0	-	-	-	-	-	-	-	-	-	-	-	2,4	-	-

Load charts • Traglasten • Capacités de levage Capacidades • Capacità • Таблицы грузоподъемности

Luffing jib • Wippspitzenausleger • Volée variable • Plumín de angulación variable • Jib a volata variable • Маневровый гусек



70°
16,0 + 2,9 m



25-73 m
0° / 22°



8,9 m



360°



120 t



EN 13000

m m	16,0 + 2,9													
	25 0°	31 0°	37 0°	43 0°	49 0°	55		61		67		73		
	0°	0°	0°	0°	0°	0°	22°	0°	22°	0°	22°	0°	22°	
18,0	69,5	-	-	-	-	-	-	-	-	-	-	-	-	
20,0	64,0	-	-	-	-	-	-	-	-	-	-	-	-	
22,0	59,5	58,0	-	-	-	-	-	-	-	-	-	-	-	
24,0	55,5	55,0	-	-	-	-	-	-	-	-	-	-	-	
26,0	51,0	50,5	46,0	-	-	-	-	-	-	-	-	-	-	
28,0	44,5	46,5	45,0	37,5	-	-	-	-	-	-	-	-	-	
30,0	-	42,5	42,0	36,5	29,0	-	-	-	-	-	-	-	-	
32,0	-	39,0	38,5	35,5	28,5	-	-	-	-	-	-	-	-	
34,0	-	34,0	36,0	35,0	27,5	21,0	21,0	-	-	-	-	-	-	
36,0	-	-	33,5	33,0	26,5	20,5	20,5	15,8	-	-	-	-	-	
38,0	-	-	31,0	30,5	26,0	19,8	19,9	15,2	15,4	11,6	-	-	-	
40,0	-	-	27,0	28,5	25,0	19,2	19,3	14,7	14,9	11,0	-	8,2	-	
42,0	-	-	-	27,0	24,5	18,6	19,1	14,2	14,4	10,4	9,7	7,9	-	
44,0	-	-	-	25,0	23,5	18,0	19,0	13,7	13,9	10,0	9,5	7,5	-	
46,0	-	-	-	22,0	22,5	17,5	18,9	13,3	13,4	9,7	9,3	7,2	-	
48,0	-	-	-	-	21,0	17,0	17,7	12,9	13,0	9,3	9,1	6,9	6,6	
50,0	-	-	-	-	19,8	16,5	16,5	12,4	12,6	9,0	8,9	6,7	6,5	
52,0	-	-	-	-	17,9	16,0	16,1	11,9	12,1	8,7	8,7	6,4	6,3	
54,0	-	-	-	-	-	15,6	15,6	11,5	11,7	8,4	8,5	6,1	6,2	
56,0	-	-	-	-	-	15,1	15,1	11,0	11,2	8,1	8,2	5,8	6,0	
58,0	-	-	-	-	-	14,2	-	10,5	10,7	7,8	8,0	5,6	5,8	
60,0	-	-	-	-	-	-	-	10,2	10,2	7,5	7,7	5,4	5,6	
62,0	-	-	-	-	-	-	-	9,9	9,7	7,3	7,4	5,2	5,4	
64,0	-	-	-	-	-	-	-	9,6	-	7,0	7,1	4,9	5,1	
66,0	-	-	-	-	-	-	-	-	-	6,8	6,9	4,7	4,9	
68,0	-	-	-	-	-	-	-	-	-	6,6	6,6	4,5	4,7	
70,0	-	-	-	-	-	-	-	-	-	6,3	-	4,3	4,5	
72,0	-	-	-	-	-	-	-	-	-	-	-	4,2	4,2	
74,0	-	-	-	-	-	-	-	-	-	-	-	4,0	4,0	
76,0	-	-	-	-	-	-	-	-	-	-	-	3,8	-	



70°
25,7 + 2,9 m



25-73 m
0° / 22°



8,9 m



360°



120 t



EN 13000

m m	25,7 + 2,9													
	25 0°	31 0°	37 0°	43 0°	49 0°	55		61		67		73		
	0°	0°	0°	0°	0°	0°	22°	0°	22°	0°	22°	0°	22°	
22,0	54,0	-	-	-	-	-	-	-	-	-	-	-	-	
24,0	50,5	-	-	-	-	-	-	-	-	-	-	-	-	
26,0	47,0	46,0	-	-	-	-	-	-	-	-	-	-	-	
28,0	43,0	42,5	42,0	-	-	-	-	-	-	-	-	-	-	
30,0	39,0	38,5	38,5	-	-	-	-	-	-	-	-	-	-	
32,0	36,0	35,5	35,5	34,0	-	-	-	-	-	-	-	-	-	
34,0	-	33,0	32,5	32,0	26,0	-	-	-	-	-	-	-	-	
36,0	-	30,5	30,5	29,5	25,5	-	-	-	-	-	-	-	-	
38,0	-	28,5	28,0	27,5	25,0	19,3	19,3	-	-	-	-	-	-	
40,0	-	-	26,5	26,0	24,0	18,8	18,8	14,5	-	-	-	-	-	
42,0	-	-	24,5	24,0	23,5	18,3	18,3	14,1	14,2	10,4	-	-	-	
44,0	-	-	23,0	22,5	22,5	17,8	17,8	13,6	13,8	10,1	-	7,6	-	
46,0	-	-	-	21,5	21,0	17,3	17,3	13,2	13,4	9,7	9,5	7,3	-	
48,0	-	-	-	20,0	20,0	16,8	16,9	12,8	13,0	9,4	9,3	7,1	-	
50,0	-	-	-	19,1	18,9	16,4	16,4	12,4	12,6	9,1	9,1	6,8	-	
52,0	-	-	-	-	17,9	16,0	16,0	12,0	12,2	8,8	8,9	6,5	6,5	
54,0	-	-	-	-	16,9	15,5	15,6	11,5	11,8	8,5	8,7	6,3	6,3	
56,0	-	-	-	-	16,0	15,1	15,2	11,0	11,3	8,2	8,4	6,0	6,2	
58,0	-	-	-	-	-	14,7	14,7	10,6	10,7	8,0	8,1	5,8	6,0	
60,0	-	-	-	-	-	14,2	14,2	10,3	10,4	7,7	7,8	5,6	5,8	
62,0	-	-	-	-	-	13,5	-	10,0	10,1	7,4	7,6	5,3	5,6	
64,0	-	-	-	-	-	-	-	9,8	9,8	7,2	7,3	5,1	5,3	
66,0	-	-	-	-	-	-	-	9,5	9,5	7,0	7,1	4,9	5,1	
68,0	-	-	-	-	-	-	-	9,2	-	6,7	6,8	4,7	4,9	
70,0	-	-	-	-	-	-	-	-	-	6,5	6,6	4,5	4,7	
72,0	-	-	-	-	-	-	-	-	-	6,3	6,3	4,3	4,4	
74,0	-	-	-	-	-	-	-	-	-	-	-	4,1	4,3	
76,0	-	-	-	-	-	-	-	-	-	-	-	4,0	4,1	
78,0	-	-	-	-	-	-	-	-	-	-	-	3,8	3,9	

Load charts • Traglasten • Capacités de levage Capacidades • Capacità • Таблицы грузоподъемности

Luffing jib • Wippspitzenausleger • Volée variable • Plumín de angulación variable • Jib a volata variable • Маневровый гусек



70°
35,3 + 2,9 m



25 - 73 m
0° / 22°



8,9 m



360°



120 t



EN 13000

m m	35,3 + 2,9													
	25 0°	31 0°	37 0°	43 0°	49 0°	55		61		67		73		
	0°	22°	0°	22°	0°	22°	0°	22°	0°	22°	0°	22°	0°	22°
26,0	34,0	-	-	-	-	-	-	-	-	-	-	-	-	-
28,0	32,0	-	-	-	-	-	-	-	-	-	-	-	-	-
30,0	30,5	29,0	-	-	-	-	-	-	-	-	-	-	-	-
32,0	29,0	27,5	26,0	-	-	-	-	-	-	-	-	-	-	-
34,0	27,5	26,0	25,0	-	-	-	-	-	-	-	-	-	-	-
36,0	26,5	25,0	23,5	22,5	-	-	-	-	-	-	-	-	-	-
38,0	-	24,0	22,5	21,5	-	-	-	-	-	-	-	-	-	-
40,0	-	23,0	22,0	20,5	20,0	-	-	-	-	-	-	-	-	-
42,0	-	22,0	21,0	19,8	19,2	16,7	16,6	-	-	-	-	-	-	-
44,0	-	-	20,0	19,0	18,4	16,7	16,3	12,7	-	-	-	-	-	-
46,0	-	-	19,3	18,2	17,6	16,2	16,0	12,4	12,4	9,2	-	-	-	-
48,0	-	-	18,6	17,5	16,9	15,6	15,6	12,1	12,1	9,0	-	-	6,7	-
50,0	-	-	-	16,8	16,2	15,0	15,1	11,7	11,9	8,8	-	-	6,6	-
52,0	-	-	-	16,3	15,6	14,5	14,6	11,3	11,4	8,5	8,7	-	6,4	-
54,0	-	-	-	15,6	15,0	13,9	14,0	10,9	11,0	8,3	8,4	-	6,1	-
56,0	-	-	-	-	14,5	13,5	13,5	10,6	10,7	8,0	8,2	-	5,9	6,2
58,0	-	-	-	-	13,8	13,0	13,0	10,3	10,4	7,8	8,0	-	5,7	5,9
60,0	-	-	-	-	13,0	12,5	12,5	10,1	10,2	7,6	7,7	-	5,5	5,7
62,0	-	-	-	-	-	12,0	11,9	9,8	9,9	7,3	7,5	-	5,3	5,5
64,0	-	-	-	-	-	11,3	11,3	9,6	9,6	7,1	7,3	-	5,1	5,3
66,0	-	-	-	-	-	10,8	-	9,3	9,4	6,9	7,0	-	4,9	5,1
68,0	-	-	-	-	-	-	-	9,1	9,1	6,7	6,8	-	4,7	4,9
70,0	-	-	-	-	-	-	-	8,9	8,9	6,5	6,6	-	4,6	4,7
72,0	-	-	-	-	-	-	-	8,6	-	6,3	6,4	-	4,4	4,5
74,0	-	-	-	-	-	-	-	-	-	6,1	6,2	-	4,2	4,3
76,0	-	-	-	-	-	-	-	-	-	5,9	5,9	-	4,0	4,2
78,0	-	-	-	-	-	-	-	-	-	-	-	-	3,9	4,0
80,0	-	-	-	-	-	-	-	-	-	-	-	-	3,7	3,8
82,0	-	-	-	-	-	-	-	-	-	-	-	-	3,6	3,6



70°
45,0 + 2,9 m



25 - 73 m
0° / 22°



8,9 m



360°



120 t



EN 13000

m m	45,0 + 2,9													
	25 0°	31 0°	37 0°	43 0°	49 0°	55		61		67		73		
	0°	22°	0°	22°	0°	22°	0°	22°	0°	22°	0°	22°	0°	22°
30,0	23,0	-	-	-	-	-	-	-	-	-	-	-	-	-
32,0	23,0	-	-	-	-	-	-	-	-	-	-	-	-	-
34,0	21,5	19,6	-	-	-	-	-	-	-	-	-	-	-	-
36,0	20,5	18,6	-	-	-	-	-	-	-	-	-	-	-	-
38,0	19,1	17,7	16,8	-	-	-	-	-	-	-	-	-	-	-
40,0	18,0	16,9	16,0	14,9	-	-	-	-	-	-	-	-	-	-
42,0	-	16,2	15,3	14,2	-	-	-	-	-	-	-	-	-	-
44,0	-	15,5	14,6	13,6	13,1	-	-	-	-	-	-	-	-	-
46,0	-	14,9	14,0	13,0	12,5	11,1	-	-	-	-	-	-	-	-
48,0	-	-	13,4	12,4	11,9	11,1	11,2	9,7	-	-	-	-	-	-
50,0	-	-	12,9	11,9	11,4	10,6	10,7	9,6	-	7,4	-	-	-	-
52,0	-	-	12,4	11,5	11,0	10,2	10,2	9,4	9,6	7,4	-	-	5,4	-
54,0	-	-	-	11,1	10,6	9,7	9,8	9,1	9,2	7,2	-	-	5,4	-
56,0	-	-	-	10,7	10,2	9,3	9,4	8,7	8,8	7,1	7,2	-	5,2	-
58,0	-	-	-	10,3	9,8	8,9	9,0	8,3	8,5	6,9	7,0	-	5,1	-
60,0	-	-	-	-	9,4	8,5	8,6	8,0	8,1	6,8	6,9	-	5,0	-
62,0	-	-	-	-	9,1	8,2	8,2	7,6	7,7	6,6	6,7	-	4,8	5,0
64,0	-	-	-	-	8,7	7,8	7,9	7,3	7,4	6,5	6,6	-	4,7	4,8
66,0	-	-	-	-	-	7,5	7,5	7,0	7,1	6,3	6,4	-	4,5	4,7
68,0	-	-	-	-	-	7,2	7,2	6,7	6,8	6,1	6,3	-	4,4	4,5
70,0	-	-	-	-	-	6,9	-	6,4	6,5	5,9	6,0	-	4,2	4,4
72,0	-	-	-	-	-	-	-	6,2	6,2	5,7	5,8	-	4,1	4,2
74,0	-	-	-	-	-	-	-	5,9	5,9	5,4	5,6	-	4,0	4,1
76,0	-	-	-	-	-	-	-	-	-	5,2	5,3	-	3,8	3,9
78,0	-	-	-	-	-	-	-	-	-	5,0	5,1	-	3,7	3,8
80,0	-	-	-	-	-	-	-	-	-	4,8	4,8	-	3,5	3,7
82,0	-	-	-	-	-	-	-	-	-	-	-	-	3,4	3,5
84,0	-	-	-	-	-	-	-	-	-	-	-	-	3,3	3,4
86,0	-	-	-	-	-	-	-	-	-	-	-	-	3,2	3,2

Load charts • Traglasten • Capacités de levage Capacidades • Capacità • Таблицы грузоподъемности

Luffing jib • Wippspitzenausleger • Volée variable • Plumín de angulación variable • Jib a volata variable • Маневровый гусек



70°
49,8 + 2,9 m



25 - 73 m
0° / 22°



8,9 m



360°



120 t



EN 13000

m m	49,8 + 2,9													
	25 0°	31 0°	37 0°	43 0°	49 0°	55		61		67		73		
	0°	22°	0°	22°	0°	22°	0°	22°	0°	22°	0°	22°	0°	22°
34,0	18,2	-	-	-	-	-	-	-	-	-	-	-	-	-
36,0	17,3	16,2	-	-	-	-	-	-	-	-	-	-	-	-
38,0	16,5	15,4	-	-	-	-	-	-	-	-	-	-	-	-
40,0	15,7	14,7	13,8	-	-	-	-	-	-	-	-	-	-	-
42,0	15,0	14,0	13,1	-	-	-	-	-	-	-	-	-	-	-
44,0	-	13,4	12,5	11,5	-	-	-	-	-	-	-	-	-	-
46,0	-	12,8	12,0	11,1	10,7	-	-	-	-	-	-	-	-	-
48,0	-	12,3	11,5	10,7	10,2	8,8	-	-	-	-	-	-	-	-
50,0	-	-	11,1	10,2	9,8	8,8	8,9	7,8	-	-	-	-	-	-
52,0	-	-	10,7	9,8	9,3	8,4	8,5	7,8	-	-	6,2	-	-	-
54,0	-	-	10,3	9,4	8,9	8,0	8,1	7,5	7,5	6,2	-	-	-	-
56,0	-	-	-	9,0	8,5	7,6	7,7	7,1	7,2	6,1	-	-	4,4	-
58,0	-	-	-	8,6	8,1	7,3	7,3	6,8	7,0	5,9	6,0	-	4,3	-
60,0	-	-	-	8,2	7,8	6,9	7,0	6,5	6,7	5,7	5,9	-	4,2	-
62,0	-	-	-	-	7,5	6,6	6,7	6,2	6,3	5,5	5,7	-	4,1	-
64,0	-	-	-	-	7,1	6,3	6,4	5,9	6,0	5,3	5,5	-	4,0	4,2
66,0	-	-	-	-	6,8	6,0	6,1	5,6	5,7	5,1	5,3	-	3,9	4,1
68,0	-	-	-	-	-	5,8	5,8	5,4	5,5	4,8	5,0	-	3,8	4,0
70,0	-	-	-	-	-	5,5	5,5	5,1	5,2	4,6	4,7	-	3,7	3,9
72,0	-	-	-	-	-	5,2	-	4,9	4,9	4,3	4,5	-	3,6	3,8
74,0	-	-	-	-	-	-	-	4,7	4,7	4,1	4,3	-	3,5	3,7
76,0	-	-	-	-	-	-	-	4,4	4,5	3,9	4,0	-	3,3	3,5
78,0	-	-	-	-	-	-	-	4,2	-	3,7	3,8	-	3,2	3,4
80,0	-	-	-	-	-	-	-	-	-	3,5	3,6	-	3,0	3,2
82,0	-	-	-	-	-	-	-	-	-	3,4	3,4	-	2,9	3,0
84,0	-	-	-	-	-	-	-	-	-	3,2	-	-	2,7	2,8
86,0	-	-	-	-	-	-	-	-	-	-	-	-	2,5	2,6
88,0	-	-	-	-	-	-	-	-	-	-	-	-	2,4	2,5



70°
54,6 + 2,9 m



25 - 73 m
0° / 22°



8,9 m



360°



120 t



EN 13000

m m	54,6 + 2,9													
	25 0°	31 0°	37 0°	43 0°	49 0°	55		61		67		73		
	0°	22°	0°	22°	0°	22°	0°	22°	0°	22°	0°	22°	0°	22°
36,0	16,1	-	-	-	-	-	-	-	-	-	-	-	-	-
38,0	15,3	13,5	-	-	-	-	-	-	-	-	-	-	-	-
40,0	14,6	12,9	-	-	-	-	-	-	-	-	-	-	-	-
42,0	13,9	12,3	11,4	-	-	-	-	-	-	-	-	-	-	-
44,0	13,2	11,7	11,1	-	-	-	-	-	-	-	-	-	-	-
46,0	-	11,4	10,6	9,6	-	-	-	-	-	-	-	-	-	-
48,0	-	10,9	10,1	9,2	-	-	-	-	-	-	-	-	-	-
50,0	-	10,4	9,7	8,7	8,3	7,0	-	-	-	-	-	-	-	-
52,0	-	-	9,3	8,3	7,9	7,0	7,0	5,8	-	-	-	-	-	-
54,0	-	-	8,9	8,0	7,5	6,6	6,7	5,8	-	-	-	-	-	-
56,0	-	-	8,5	7,6	7,2	6,3	6,4	5,7	5,6	4,8	-	-	-	-
58,0	-	-	-	7,3	6,8	6,0	6,0	5,4	5,6	4,8	-	-	3,5	-
60,0	-	-	-	7,0	6,5	5,7	5,7	5,1	5,3	4,6	4,6	-	3,5	-
62,0	-	-	-	6,6	6,2	5,4	5,4	4,8	5,0	4,3	4,6	-	3,4	-
64,0	-	-	-	-	5,9	5,1	5,2	4,6	4,7	4,1	4,3	-	3,3	-
66,0	-	-	-	-	5,6	4,8	4,9	4,3	4,5	3,9	4,1	-	3,2	3,3
68,0	-	-	-	-	5,4	4,6	4,6	4,1	4,2	3,7	3,9	-	3,1	3,3
70,0	-	-	-	-	-	4,4	4,4	3,9	4,0	3,5	3,7	-	2,9	3,2
72,0	-	-	-	-	-	4,1	4,1	3,6	3,7	3,2	3,4	-	2,7	3,0
74,0	-	-	-	-	-	3,9	-	3,5	3,5	3,1	3,2	-	2,5	2,8
76,0	-	-	-	-	-	-	-	3,3	3,3	2,9	3,0	-	2,3	2,6
78,0	-	-	-	-	-	-	-	3,1	3,1	2,7	2,8	-	2,2	2,4
80,0	-	-	-	-	-	-	-	2,9	-	2,5	2,6	-	2,0	2,2
82,0	-	-	-	-	-	-	-	-	-	2,4	2,5	-	1,9	2,0
84,0	-	-	-	-	-	-	-	-	-	2,2	2,3	-	1,7	1,9
86,0	-	-	-	-	-	-	-	-	-	2,0	-	-	-	1,7

Load charts • Traglasten • Capacités de levage Capacidades • Capacità • Таблицы грузоподъемности

Luffing jib • Wippspitzenausleger • Volée variable • Plumín de angulación variable • Jib a volata variable • Маневровый гусек



60°
16,0 + 2,9 m



25 - 73 m
0° / 22°



8,9 m



360°



120 t



EN 13000

m m	16,0 + 2,9													
	25 0°	31 0°	37 0°	43 0°	49 0°	55		61		67		73		
	0°	22°	0°	22°	0°	22°	0°	22°	0°	22°	0°	22°	0°	22°
26,0	48,5	-	-	-	-	-	-	-	-	-	-	-	-	-
28,0	44,5	44,0	-	-	-	-	-	-	-	-	-	-	-	-
30,0	40,5	40,0	-	-	-	-	-	-	-	-	-	-	-	-
32,0	37,5	37,0	36,5	-	-	-	-	-	-	-	-	-	-	-
34,0	-	34,0	34,0	-	-	-	-	-	-	-	-	-	-	-
36,0	-	32,0	31,5	31,0	-	-	-	-	-	-	-	-	-	-
38,0	-	29,5	29,5	29,0	-	-	-	-	-	-	-	-	-	-
40,0	-	-	27,5	27,0	26,0	-	-	-	-	-	-	-	-	-
42,0	-	-	25,5	25,5	25,0	-	-	-	-	-	-	-	-	-
44,0	-	-	24,0	24,0	23,5	18,9	19,0	-	-	-	-	-	-	-
46,0	-	-	-	22,5	22,0	18,3	18,4	14,0	-	-	-	-	-	-
48,0	-	-	-	21,0	21,0	17,8	17,8	13,5	-	-	-	-	-	-
50,0	-	-	-	20,0	19,7	17,2	17,3	13,0	13,2	9,5	-	-	-	-
52,0	-	-	-	-	18,7	16,7	16,8	12,6	12,8	9,1	-	-	-	-
54,0	-	-	-	-	17,7	16,2	16,3	12,2	12,3	8,8	-	6,5	-	-
56,0	-	-	-	-	-	15,8	15,8	11,6	11,7	8,5	8,6	6,2	-	-
58,0	-	-	-	-	-	15,3	15,3	11,0	11,1	8,2	8,4	6,0	-	-
60,0	-	-	-	-	-	14,9	-	10,7	10,7	7,9	8,1	5,7	5,9	-
62,0	-	-	-	-	-	-	-	10,3	10,4	7,7	7,8	5,5	5,7	-
64,0	-	-	-	-	-	-	-	10,0	10,1	7,4	7,5	5,3	5,5	-
66,0	-	-	-	-	-	-	-	9,7	9,7	7,1	7,2	5,0	5,2	-
68,0	-	-	-	-	-	-	-	-	-	6,9	7,0	4,8	5,0	-
70,0	-	-	-	-	-	-	-	-	-	6,7	6,7	4,6	4,8	-
72,0	-	-	-	-	-	-	-	-	-	6,4	-	4,4	4,6	-
74,0	-	-	-	-	-	-	-	-	-	-	-	4,3	4,4	-
76,0	-	-	-	-	-	-	-	-	-	-	-	4,1	4,1	-
78,0	-	-	-	-	-	-	-	-	-	-	-	3,9	-	-



60°
25,7 + 2,9 m



25 - 73 m
0° / 22°



8,9 m



360°



120 t



EN 13000

m m	25,7 + 2,9													
	25 0°	31 0°	37 0°	43 0°	49 0°	55		61		67		73		
	0°	22°	0°	22°	0°	22°	0°	22°	0°	22°	0°	22°	0°	22°
30,0	35,5	-	-	-	-	-	-	-	-	-	-	-	-	-
32,0	32,5	-	-	-	-	-	-	-	-	-	-	-	-	-
34,0	30,0	30,0	-	-	-	-	-	-	-	-	-	-	-	-
36,0	28,0	27,5	-	-	-	-	-	-	-	-	-	-	-	-
38,0	-	25,5	25,5	-	-	-	-	-	-	-	-	-	-	-
40,0	-	24,0	23,5	-	-	-	-	-	-	-	-	-	-	-
42,0	-	22,5	22,0	21,5	-	-	-	-	-	-	-	-	-	-
44,0	-	-	21,0	20,0	-	-	-	-	-	-	-	-	-	-
46,0	-	-	19,5	19,0	18,6	-	-	-	-	-	-	-	-	-
48,0	-	-	18,4	17,9	17,5	17,1	-	-	-	-	-	-	-	-
50,0	-	-	-	16,9	16,5	16,1	16,1	-	-	-	-	-	-	-
52,0	-	-	-	16,0	15,6	15,2	15,2	12,9	-	-	-	-	-	-
54,0	-	-	-	15,1	14,8	14,4	14,4	12,6	-	-	-	-	-	-
56,0	-	-	-	-	14,0	13,6	13,6	12,2	12,3	8,9	-	-	-	-
58,0	-	-	-	-	13,3	12,9	12,9	11,8	11,9	8,6	-	-	-	-
60,0	-	-	-	-	12,6	12,2	12,2	11,5	11,6	8,3	8,5	6,1	-	-
62,0	-	-	-	-	-	11,6	11,6	10,9	10,8	8,0	8,2	5,8	-	-
64,0	-	-	-	-	-	11,0	11,0	10,4	10,5	7,8	7,9	5,6	-	-
66,0	-	-	-	-	-	10,4	-	10,1	10,2	7,5	7,6	5,4	5,6	-
68,0	-	-	-	-	-	-	-	9,7	9,7	7,3	7,4	5,2	5,4	-
70,0	-	-	-	-	-	-	-	9,2	9,2	7,0	7,1	5,0	5,2	-
72,0	-	-	-	-	-	-	-	8,7	-	6,8	6,9	4,7	4,9	-
74,0	-	-	-	-	-	-	-	-	-	6,6	6,6	4,6	4,7	-
76,0	-	-	-	-	-	-	-	-	-	6,3	6,4	4,4	4,5	-
78,0	-	-	-	-	-	-	-	-	-	6,1	-	4,2	4,3	-
80,0	-	-	-	-	-	-	-	-	-	-	-	4,0	4,1	-
82,0	-	-	-	-	-	-	-	-	-	-	-	3,8	3,9	-
84,0	-	-	-	-	-	-	-	-	-	-	-	3,7	-	-

Load charts • Traglasten • Capacités de levage Capacidades • Capacità • Таблицы грузоподъемности

Luffing jib • Wippspitzenausleger • Volée variable • Plumín de angulación variable • Jib a volata variable • Маневровый гусек



60°
35,3 + 2,9 m



25 - 73 m
0° / 22°



8,9 m



360°



120 t



EN 13000

m m	35,3 + 2,9													
	25 0°	31 0°	37 0°	43 0°	49 0°	55 0° 22°		61 0° 22°		67 0° 22°		73 0° 22°		
36,0	23,0	-	-	-	-	-	-	-	-	-	-	-	-	-
38,0	22,5	-	-	-	-	-	-	-	-	-	-	-	-	-
40,0	21,5	20,5	-	-	-	-	-	-	-	-	-	-	-	-
42,0	20,0	19,4	-	-	-	-	-	-	-	-	-	-	-	-
44,0	-	18,5	17,6	-	-	-	-	-	-	-	-	-	-	-
46,0	-	17,4	16,9	-	-	-	-	-	-	-	-	-	-	-
48,0	-	16,3	16,0	15,3	-	-	-	-	-	-	-	-	-	-
50,0	-	-	15,1	14,5	-	-	-	-	-	-	-	-	-	-
52,0	-	-	14,2	13,7	13,3	-	-	-	-	-	-	-	-	-
54,0	-	-	13,4	12,9	12,5	-	-	-	-	-	-	-	-	-
56,0	-	-	-	12,2	11,8	11,4	11,4	-	-	-	-	-	-	-
58,0	-	-	-	11,6	11,2	10,8	10,8	10,4	-	-	-	-	-	-
60,0	-	-	-	10,9	10,6	10,2	10,2	9,8	9,8	-	-	-	-	-
62,0	-	-	-	-	10,0	9,6	9,6	9,3	9,3	8,0	-	-	-	-
64,0	-	-	-	-	9,5	9,1	9,1	8,8	8,8	7,8	-	5,7	-	-
66,0	-	-	-	-	9,0	8,6	8,6	8,3	8,3	7,6	7,7	5,5	-	-
68,0	-	-	-	-	-	8,2	8,2	7,9	7,9	7,4	7,5	5,3	-	-
70,0	-	-	-	-	-	7,7	7,7	7,4	7,4	7,1	7,2	5,1	-	-
72,0	-	-	-	-	-	7,3	-	7,0	7,0	6,8	6,8	4,9	5,1	-
74,0	-	-	-	-	-	-	-	6,6	6,6	6,4	6,4	4,7	4,9	-
76,0	-	-	-	-	-	-	-	6,3	6,3	6,1	6,1	4,6	4,7	-
78,0	-	-	-	-	-	-	-	-	-	5,7	5,7	4,4	4,5	-
80,0	-	-	-	-	-	-	-	-	-	5,4	5,4	4,2	4,4	-
82,0	-	-	-	-	-	-	-	-	-	5,0	5,0	4,1	4,2	-
84,0	-	-	-	-	-	-	-	-	-	-	-	3,9	4,0	-
86,0	-	-	-	-	-	-	-	-	-	-	-	3,7	3,8	-
88,0	-	-	-	-	-	-	-	-	-	-	-	3,6	3,6	-



60°
45,0 + 2,9 m



25 - 73 m
0° / 22°



8,9 m



360°



120 t



EN 13000

m m	45,0 + 2,9													
	25 0°	31 0°	37 0°	43 0°	49 0°	55 0° 22°		61 0° 22°		67 0° 22°		73 0° 22°		
42,0	15,6	-	-	-	-	-	-	-	-	-	-	-	-	-
44,0	14,4	-	-	-	-	-	-	-	-	-	-	-	-	-
46,0	13,5	12,1	-	-	-	-	-	-	-	-	-	-	-	-
48,0	12,6	11,6	-	-	-	-	-	-	-	-	-	-	-	-
50,0	-	11,2	10,5	-	-	-	-	-	-	-	-	-	-	-
52,0	-	10,8	10,0	-	-	-	-	-	-	-	-	-	-	-
54,0	-	10,3	9,6	8,7	-	-	-	-	-	-	-	-	-	-
56,0	-	-	9,2	8,3	-	-	-	-	-	-	-	-	-	-
58,0	-	-	8,8	8,0	7,5	-	-	-	-	-	-	-	-	-
60,0	-	-	8,5	7,6	7,2	6,4	6,1	-	-	-	-	-	-	-
62,0	-	-	-	7,3	6,8	6,0	6,1	-	-	-	-	-	-	-
64,0	-	-	-	7,0	6,5	5,7	5,8	6,9	-	-	-	-	-	-
66,0	-	-	-	-	6,2	5,5	5,5	5,0	5,1	-	-	-	-	-
68,0	-	-	-	-	6,0	5,2	5,2	4,7	4,8	4,2	-	-	-	-
70,0	-	-	-	-	5,7	4,9	4,9	4,4	4,6	4,0	-	3,8	-	-
72,0	-	-	-	-	-	4,7	4,7	4,2	4,3	3,8	4,0	3,8	-	-
74,0	-	-	-	-	-	4,4	4,4	4,0	4,1	3,6	3,8	3,6	-	-
76,0	-	-	-	-	-	4,2	-	3,8	3,9	3,4	3,6	3,4	3,5	-
78,0	-	-	-	-	-	-	-	3,6	3,6	3,2	3,3	3,3	3,5	-
80,0	-	-	-	-	-	-	-	3,4	3,4	3,0	3,1	3,1	3,2	-
82,0	-	-	-	-	-	-	-	3,2	-	2,8	2,9	2,9	3,0	-
84,0	-	-	-	-	-	-	-	-	-	2,6	2,7	2,7	2,7	-
86,0	-	-	-	-	-	-	-	-	-	2,5	2,5	2,4	2,5	-
88,0	-	-	-	-	-	-	-	-	-	2,3	-	2,2	2,2	-
90,0	-	-	-	-	-	-	-	-	-	-	-	2,0	2,0	-
92,0	-	-	-	-	-	-	-	-	-	-	-	1,7	1,8	-

Load charts • Traglasten • Capacités de levage Capacidades • Capacità • Таблицы грузоподъемности

Luffing jib • Wippspitzenausleger • Volée variable • Plumín de angulación variable • Jib a volata variable • Маневровый гусек



60°
49,8 + 2,9 m



25 - 73 m
0° / 22°



8,9 m



360°



120 t



EN 13000

m m	49,8 + 2,9									
	25 0°	31 0°	37 0°	43 0°	49 0°	55 0°	55 22°	61 0°	61 22°	
44,0	11,5	-	-	-	-	-	-	-	-	-
46,0	11,2	-	-	-	-	-	-	-	-	-
48,0	10,7	9,8	-	-	-	-	-	-	-	-
50,0	10,2	9,4	-	-	-	-	-	-	-	-
52,0	-	9,0	8,2	-	-	-	-	-	-	-
54,0	-	8,6	7,9	-	-	-	-	-	-	-
56,0	-	8,2	7,5	6,6	-	-	-	-	-	-
58,0	-	-	7,2	6,3	-	-	-	-	-	-
60,0	-	-	6,9	6,0	-	-	-	-	-	-
62,0	-	-	6,5	5,7	5,2	-	-	-	-	-
64,0	-	-	-	5,4	5,0	4,2	4,0	-	-	-
66,0	-	-	-	5,2	4,7	3,9	4,0	-	-	-
68,0	-	-	-	4,9	4,5	3,7	3,7	3,3	-	-
70,0	-	-	-	-	4,2	3,4	3,5	3,1	3,2	-
72,0	-	-	-	-	4,0	3,2	3,3	2,9	3,0	-
74,0	-	-	-	-	3,8	3,0	3,1	2,7	2,8	-
76,0	-	-	-	-	-	2,8	2,9	2,5	2,6	-
78,0	-	-	-	-	-	2,6	2,7	2,3	2,4	-
80,0	-	-	-	-	-	2,5	-	2,1	2,2	-
82,0	-	-	-	-	-	-	-	2,0	2,0	-
84,0	-	-	-	-	-	-	-	1,8	1,8	-
86,0	-	-	-	-	-	-	-	1,7	-	-



60°
54,6 + 2,9 m



25 - 73 m
0° / 22°



8,9 m



360°



120 t



EN 13000

m m	54,6 + 2,9			
	31 0°	37 0°	43 0°	49 0°
52,0	7,5	-	-	-
54,0	7,1	-	-	-
56,0	6,8	6,1	-	-
58,0	6,5	5,8	-	-
60,0	6,2	5,5	4,7	-
62,0	-	5,3	4,4	-
64,0	-	5,0	4,2	-
66,0	-	-	3,9	3,5
68,0	-	-	3,7	3,2
70,0	-	-	3,5	3,0
72,0	-	-	-	2,9
74,0	-	-	-	2,7
76,0	-	-	-	2,5

Load charts • Traglasten • Capacités de levage Capacidades • Capacità • Таблицы грузоподъемности

Mega-Wing-Lift

Working range • Arbeitsbereiche • Diagramme de levage • Gama de trabajo • Area di lavoro • Грузовысотные характеристики



81°
35,3 - 54,6 m



2,9 + 25 - 79 m



8,9 m



360°

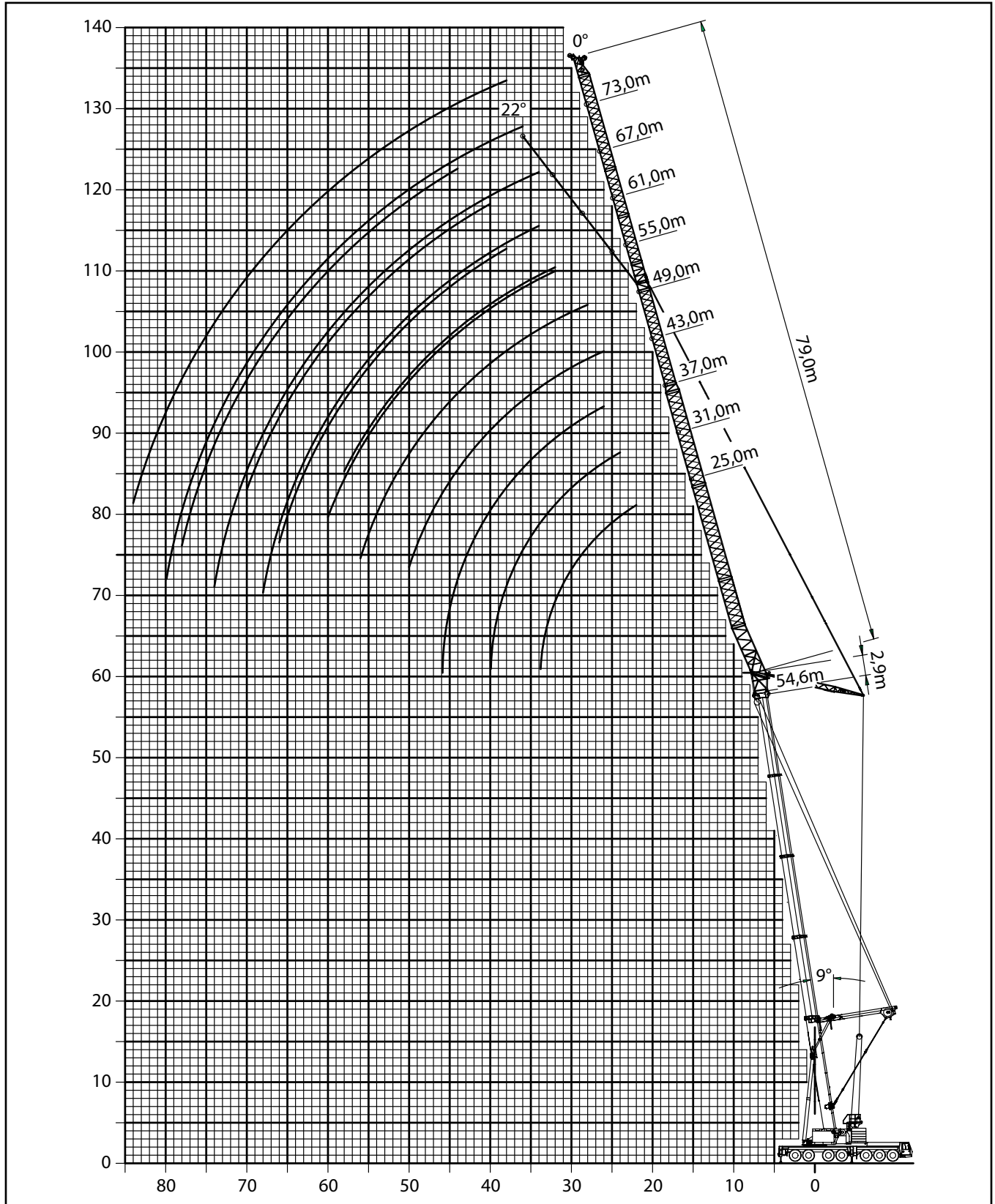

Load charts • Traglasten • Capacités de levage Capacidades • Capacità • Таблицы грузоподъемности

Mega-Wing-Lift

Working range • Arbeitsbereiche • Diagramme de levage • Gama de trabajo • Area di lavoro • Грузовысотные характеристики



70°
35,3 - 54,6 m



2,9 + 25 - 79 m



8,9 m



360°

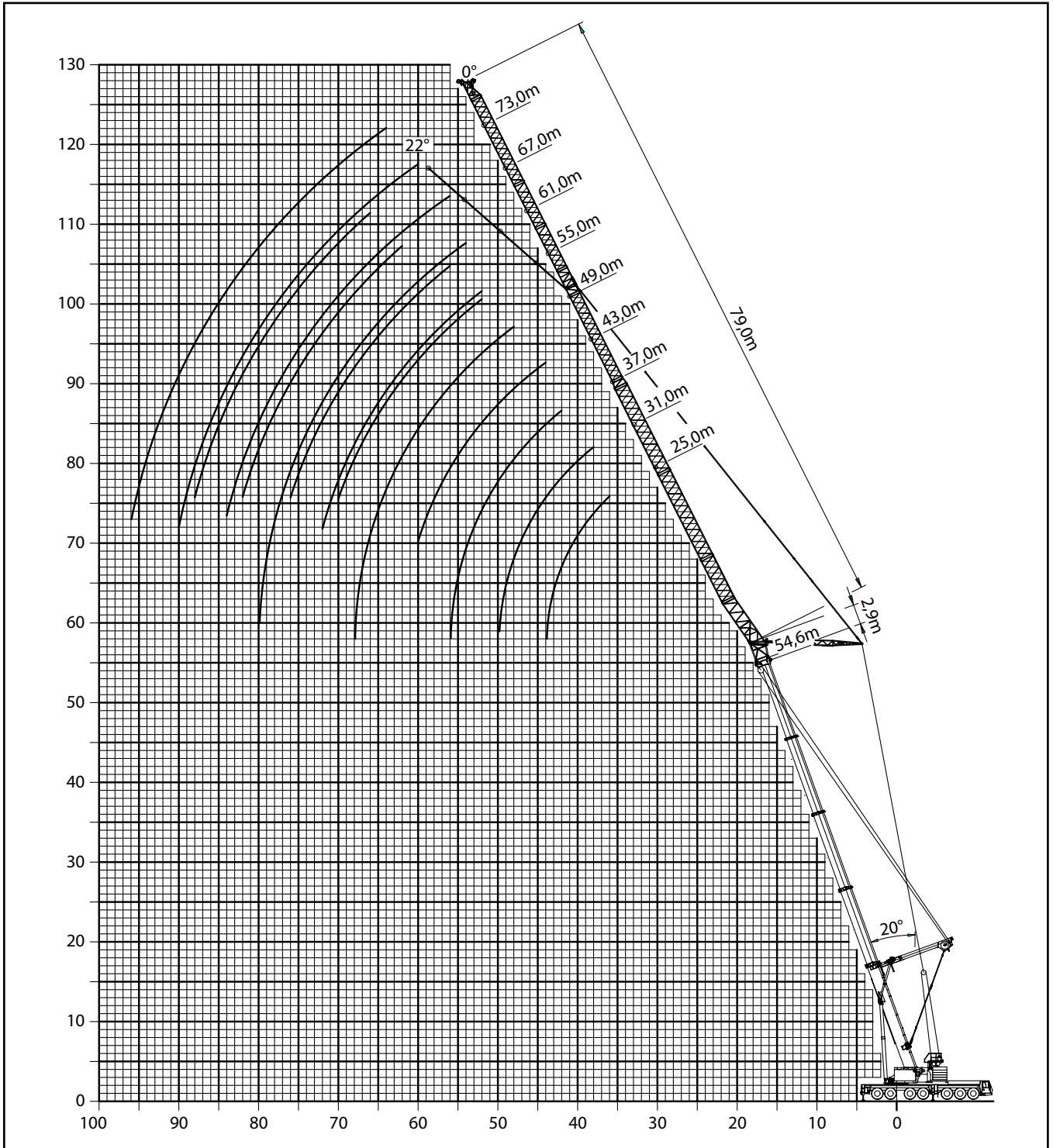

Load charts • Traglasten • Capacités de levage Capacidades • Capacità • Таблицы грузоподъемности

Mega-Wing-Lift

Luffing jib • Wippspitzenausleger • Volée variable • Plumín de angulación variable • Jib a volata variable • Маневровый гусек



81°
35,3 + 2,9 m



25 - 79 m
0° / 22°



8,9 m



360°



160 t



EN 13000

m m	35,3 + 2,9													
	25 0°	31 0°	37 0°	43 0°	49 0°	55		61		67		73		79 0°
	0°	0°	0°	0°	0°	0°	22°	0°	22°	0°	22°	0°	22°	0°
15,0	64,0	-	-	-	-	-	-	-	-	-	-	-	-	-
16,0	63,5	48,5	-	-	-	-	-	-	-	-	-	-	-	-
18,0	59,0	48,5	38,5	-	-	-	-	-	-	-	-	-	-	-
20,0	55,0	48,5	38,5	31,5	-	-	-	-	-	-	-	-	-	-
22,0	51,0	48,5	38,5	31,5	26,5	-	-	-	-	-	-	-	-	-
24,0	48,0	48,5	38,5	31,5	26,5	21,5	-	-	-	-	-	-	-	-
26,0	45,5	48,5	38,5	31,5	26,5	21,5	22,0	17,9	-	-	-	-	-	-
28,0	43,5	47,0	38,5	31,5	26,5	21,5	22,0	17,9	-	14,9	-	-	-	-
30,0	-	45,0	38,5	31,5	26,5	21,5	22,0	17,9	18,5	14,9	-	11,9	-	-
32,0	-	42,5	38,5	31,5	26,5	21,5	22,0	17,9	18,5	14,9	-	11,9	-	9,3
34,0	-	37,0	38,5	31,5	26,5	21,5	22,0	17,9	18,5	14,9	14,2	11,9	-	9,3
36,0	-	-	37,0	31,5	26,5	21,5	22,0	17,9	18,4	14,9	14,0	11,9	-	9,3
38,0	-	-	34,5	31,5	26,5	21,5	22,0	17,9	18,3	14,9	13,7	11,9	9,8	9,3
40,0	-	-	29,5	31,5	26,5	21,5	22,0	17,9	18,1	14,9	13,4	11,9	9,5	9,3
42,0	-	-	-	30,5	26,5	21,5	22,0	17,9	17,9	14,9	12,9	11,8	9,3	9,3
44,0	-	-	-	27,5	26,5	21,5	22,0	17,9	17,8	14,9	12,3	11,5	9,0	9,3
46,0	-	-	-	23,5	26,0	21,0	21,5	17,9	17,7	14,9	11,8	11,2	8,8	9,0
48,0	-	-	-	-	25,5	21,0	21,5	17,9	17,6	14,7	11,6	10,9	8,6	8,7
50,0	-	-	-	-	22,5	20,5	21,0	17,9	17,5	14,4	11,4	10,6	8,4	8,5
52,0	-	-	-	-	19,3	20,0	20,5	17,9	17,5	13,8	11,2	10,3	8,3	8,2
54,0	-	-	-	-	-	19,9	20,5	17,9	17,5	13,3	11,1	10,0	8,1	8,0
56,0	-	-	-	-	-	18,5	18,7	17,9	17,4	12,8	10,9	9,7	8,0	7,7
58,0	-	-	-	-	-	15,9	-	17,9	17,4	12,4	10,8	9,4	7,8	7,5
60,0	-	-	-	-	-	-	-	17,3	17,4	12,1	10,7	9,1	7,7	7,2
62,0	-	-	-	-	-	-	-	15,4	-	11,8	10,6	8,9	7,6	7,0
64,0	-	-	-	-	-	-	-	13,2	-	11,5	10,5	8,6	7,5	6,8
66,0	-	-	-	-	-	-	-	-	-	11,2	10,5	8,4	7,4	6,5
68,0	-	-	-	-	-	-	-	-	-	11,0	-	8,2	7,4	6,3
70,0	-	-	-	-	-	-	-	-	-	-	-	8,0	7,3	6,2
72,0	-	-	-	-	-	-	-	-	-	-	-	7,8	7,3	6,0
74,0	-	-	-	-	-	-	-	-	-	-	-	7,7	7,2	5,8
76,0	-	-	-	-	-	-	-	-	-	-	-	-	-	5,7
78,0	-	-	-	-	-	-	-	-	-	-	-	-	-	5,5
80,0	-	-	-	-	-	-	-	-	-	-	-	-	-	5,4

Load charts • Traglasten • Capacités de levage Capacidades • Capacità • Таблицы грузоподъемности

Mega-Wing-Lift

Luffing jib • Wippspitzenausleger • Volée variable • Plumín de angulación variable • Jib a volata variable • Маневровый гусек



81°
45,0 + 2,9 m



25 - 79 m
0° / 22°



8,9 m



360°



160 t



EN 13000

m m	45,0 + 2,9													
	25 0°	31 0°	37 0°	43 0°	49 0°	55		61		67		73		79 0°
						0°	22°	0°	22°	0°	22°	0°	22°	0°
18,0	54,5	-	-	-	-	-	-	-	-	-	-	-	-	-
20,0	51,0	46,5	-	-	-	-	-	-	-	-	-	-	-	-
22,0	48,5	45,0	36,5	-	-	-	-	-	-	-	-	-	-	-
24,0	47,0	43,0	36,5	29,0	-	-	-	-	-	-	-	-	-	-
26,0	46,0	41,0	36,5	29,0	24,5	-	-	-	-	-	-	-	-	-
28,0	45,0	40,0	36,5	29,0	24,5	20,0	20,5	-	-	-	-	-	-	-
30,0	43,0	39,0	35,5	29,0	24,5	20,0	20,5	16,6	-	13,9	-	-	-	-
32,0	38,5	38,0	34,5	29,0	24,5	20,0	20,5	16,6	-	13,9	-	11,0	-	-
34,0	-	36,5	33,5	29,0	24,5	20,0	20,5	16,6	17,2	13,9	-	11,0	-	8,6
36,0	-	34,0	32,5	29,0	24,5	20,0	20,5	16,6	17,2	13,9	13,8	11,0	-	8,6
38,0	-	-	31,5	29,0	24,5	20,0	20,5	16,6	17,2	13,9	13,6	11,0	-	8,6
40,0	-	-	30,5	28,0	24,5	20,0	20,5	16,6	17,2	13,9	13,1	11,0	-	8,6
42,0	-	-	28,5	27,5	24,5	20,0	20,5	16,6	17,2	13,9	12,4	11,0	9,4	8,6
44,0	-	-	-	26,5	24,5	20,0	20,5	16,6	17,2	13,9	12,1	11,0	9,2	8,6
46,0	-	-	-	24,5	24,5	20,0	20,5	16,6	17,2	13,9	11,9	11,0	9,0	8,6
48,0	-	-	-	22,5	24,0	19,9	20,5	16,6	17,1	13,9	11,7	10,9	8,8	8,6
50,0	-	-	-	-	23,0	19,8	20,5	16,6	17,0	13,9	11,5	10,7	8,6	8,6
52,0	-	-	-	-	21,5	19,6	20,0	16,6	17,0	13,9	11,3	10,4	8,4	8,3
54,0	-	-	-	-	20,5	19,3	19,9	16,6	17,0	13,6	11,1	10,1	8,2	8,1
56,0	-	-	-	-	-	18,9	19,3	16,6	17,0	13,2	11,0	9,9	8,1	7,8
58,0	-	-	-	-	-	18,6	18,7	16,6	17,0	12,7	10,9	9,6	8,0	7,6
60,0	-	-	-	-	-	17,0	-	16,6	17,0	12,3	10,8	9,3	7,8	7,3
62,0	-	-	-	-	-	-	-	16,6	16,0	12,0	10,7	9,1	7,7	7,1
64,0	-	-	-	-	-	-	-	16,6	16,1	11,7	10,6	8,8	7,6	7,0
66,0	-	-	-	-	-	-	-	14,0	-	11,4	10,5	8,6	7,5	6,8
68,0	-	-	-	-	-	-	-	-	-	11,2	10,5	8,4	7,4	6,6
70,0	-	-	-	-	-	-	-	-	-	11,0	-	8,2	7,4	6,4
72,0	-	-	-	-	-	-	-	-	-	-	-	8,0	7,3	6,2
74,0	-	-	-	-	-	-	-	-	-	-	-	7,8	7,3	6,0
76,0	-	-	-	-	-	-	-	-	-	-	-	7,7	7,3	5,9
78,0	-	-	-	-	-	-	-	-	-	-	-	7,7	7,2	5,7
80,0	-	-	-	-	-	-	-	-	-	-	-	-	-	5,6
82,0	-	-	-	-	-	-	-	-	-	-	-	-	-	5,4

Load charts • Traglasten • Capacités de levage Capacidades • Capacità • Таблицы грузоподъемности

Mega-Wing-Lift

Luffing jib • Wippspitzenausleger • Volée variable • Plumín de angulación variable • Jib a volata variable • Маневровый гусек



81°
49,8 + 2,9 m



25 - 79 m
0° / 22°



8,9 m



360°



160 t



EN 13000

m m	49,8 + 2,9													
	25 0°	31 0°	37 0°	43 0°	49 0°	55		61		67		73		79 0°
20,0	46,0	-	-	-	-	-	-	-	-	-	-	-	-	-
22,0	44,0	39,5	-	-	-	-	-	-	-	-	-	-	-	-
24,0	42,5	37,5	33,5	-	-	-	-	-	-	-	-	-	-	-
26,0	41,5	36,5	33,0	27,0	-	-	-	-	-	-	-	-	-	-
28,0	40,0	35,5	32,0	27,0	23,0	18,7	-	-	-	-	-	-	-	-
30,0	37,5	34,5	31,0	27,0	23,0	18,7	19,1	-	-	-	-	-	-	-
32,0	35,0	33,5	30,5	27,0	23,0	18,7	19,1	15,5	-	12,9	-	-	-	-
34,0	-	32,0	29,5	26,5	23,0	18,7	19,1	15,5	-	12,9	-	10,3	-	-
36,0	-	30,0	29,0	26,0	23,0	18,7	19,1	15,5	16,0	12,9	-	10,3	-	7,8
38,0	-	28,5	27,5	25,0	23,0	18,7	19,1	15,5	16,0	12,9	13,2	10,3	-	7,8
40,0	-	-	26,0	24,0	23,0	18,7	19,1	15,5	16,0	12,9	12,3	10,3	-	7,8
42,0	-	-	24,5	23,0	22,5	18,7	19,1	15,5	16,0	12,9	12,1	10,3	9,4	7,8
44,0	-	-	23,0	22,0	22,0	18,7	19,1	15,5	16,0	12,9	12,0	10,3	9,2	7,8
46,0	-	-	-	21,0	21,0	18,7	19,1	15,5	16,0	12,9	11,8	10,3	9,0	7,8
48,0	-	-	-	19,9	20,5	18,6	19,0	15,5	16,0	12,9	11,6	10,3	8,8	7,8
50,0	-	-	-	18,8	19,6	18,1	18,5	15,5	16,0	12,9	11,5	10,3	8,6	7,8
52,0	-	-	-	-	18,8	17,7	18,0	15,5	16,0	12,9	11,3	10,3	8,4	7,8
54,0	-	-	-	-	18,0	17,2	17,4	15,5	16,0	12,9	11,2	10,0	8,3	7,8
56,0	-	-	-	-	17,1	16,5	16,7	15,5	15,9	12,9	11,0	9,8	8,1	7,8
58,0	-	-	-	-	-	15,9	16,1	15,3	15,6	12,7	10,8	9,6	8,0	7,6
60,0	-	-	-	-	-	15,2	-	14,8	15,0	12,4	10,7	9,4	7,8	7,4
62,0	-	-	-	-	-	-	-	14,3	14,5	12,0	10,6	9,1	7,7	7,2
64,0	-	-	-	-	-	-	-	13,5	13,9	11,7	10,6	8,9	7,6	7,0
66,0	-	-	-	-	-	-	-	12,7	-	11,5	10,5	8,6	7,5	6,8
68,0	-	-	-	-	-	-	-	11,8	-	11,3	10,4	8,4	7,4	6,6
70,0	-	-	-	-	-	-	-	-	-	11,0	-	8,2	7,4	6,4
72,0	-	-	-	-	-	-	-	-	-	10,6	-	8,0	7,3	6,2
74,0	-	-	-	-	-	-	-	-	-	-	-	7,9	7,3	6,1
76,0	-	-	-	-	-	-	-	-	-	-	-	7,7	7,2	5,9
78,0	-	-	-	-	-	-	-	-	-	-	-	7,6	-	5,7
80,0	-	-	-	-	-	-	-	-	-	-	-	-	-	5,6
82,0	-	-	-	-	-	-	-	-	-	-	-	-	-	5,5

Load charts • Traglasten • Capacités de levage Capacidades • Capacità • Таблицы грузоподъемности

Mega-Wing-Lift

Luffing jib • Wippspitzenausleger • Volée variable • Plumín de angulación variable • Jib a volata variable • Маневровый гусек



81°
54,6 + 2,9 m



25 - 79 m
0° / 22°



8,9 m



360°



160 t



EN 13000

m m	54,6 + 2,9													
	25 0°	31 0°	37 0°	43 0°	49 0°	55		61	67		73		79	
	0°	0°	0°	0°	0°	0°	22°	0°	22°	0°	22°	0°	22°	0°
22,0	39,5	-	-	-	-	-	-	-	-	-	-	-	-	-
24,0	37,0	34,0	-	-	-	-	-	-	-	-	-	-	-	-
26,0	34,5	32,5	29,5	25,0	-	-	-	-	-	-	-	-	-	-
28,0	32,5	30,5	28,5	25,0	21,5	-	-	-	-	-	-	-	-	-
30,0	30,5	28,5	27,0	24,0	21,5	17,2	-	-	-	-	-	-	-	-
32,0	28,5	27,0	25,5	23,5	21,5	17,2	17,6	-	-	-	-	-	-	-
34,0	26,5	25,5	24,0	22,5	21,5	17,2	17,6	14,3	-	11,4	-	-	-	-
36,0	-	23,5	22,5	21,5	21,0	17,2	17,6	14,3	-	11,4	-	9,5	-	-
38,0	-	22,0	21,5	20,5	20,5	17,2	17,6	14,3	14,9	11,4	-	9,5	-	7,2
40,0	-	21,0	20,5	19,3	19,5	17,2	17,6	14,3	14,9	11,4	11,9	9,5	-	7,2
42,0	-	-	19,2	18,4	18,7	17,1	17,4	14,3	14,9	11,4	11,8	9,5	-	7,2
44,0	-	-	18,1	17,4	17,9	16,6	16,8	14,3	14,9	11,4	11,7	9,5	9,1	7,2
46,0	-	-	16,9	16,5	17,1	16,0	15,8	14,3	14,9	11,4	11,6	9,5	9,0	7,2
48,0	-	-	-	15,6	16,4	15,5	14,5	14,3	14,7	11,4	11,4	9,5	8,8	7,2
50,0	-	-	-	14,8	15,6	14,6	12,9	13,9	13,9	11,4	11,3	9,5	8,6	7,2
52,0	-	-	-	-	14,9	13,7	12,6	13,5	13,2	11,4	11,2	9,5	8,4	7,2
54,0	-	-	-	-	14,2	12,8	12,4	12,8	12,4	11,4	11,0	9,5	8,3	7,2
56,0	-	-	-	-	13,4	12,1	12,1	12,1	11,9	11,2	10,9	9,5	8,1	7,2
58,0	-	-	-	-	-	11,6	11,7	11,4	11,5	10,8	10,8	9,5	8,0	7,2
60,0	-	-	-	-	-	11,0	11,2	10,8	11,0	10,4	10,6	9,3	7,9	7,2
62,0	-	-	-	-	-	10,5	-	10,3	10,5	10,0	10,2	9,1	7,7	7,2
64,0	-	-	-	-	-	-	-	9,8	10,1	9,6	9,9	8,8	7,6	7,0
66,0	-	-	-	-	-	-	-	9,4	9,6	9,2	9,5	8,5	7,5	6,8
68,0	-	-	-	-	-	-	-	8,9	-	8,8	9,1	8,3	7,5	6,6
70,0	-	-	-	-	-	-	-	-	-	8,4	8,7	8,0	7,4	6,5
72,0	-	-	-	-	-	-	-	-	-	8,0	-	7,7	7,3	6,3
74,0	-	-	-	-	-	-	-	-	-	7,6	-	7,3	7,2	6,1
76,0	-	-	-	-	-	-	-	-	-	-	-	7,0	7,1	6,0
78,0	-	-	-	-	-	-	-	-	-	-	-	6,7	6,9	5,8
80,0	-	-	-	-	-	-	-	-	-	-	-	6,3	-	5,7
82,0	-	-	-	-	-	-	-	-	-	-	-	-	-	5,5
84,0	-	-	-	-	-	-	-	-	-	-	-	-	-	5,3

Load charts • Traglasten • Capacités de levage Capacidades • Capacità • Таблицы грузоподъемности

Mega-Wing-Lift
Luffing jib • Wippspitzenausleger • Volée variable • Plumín de angulación variable • Jib a volata variable • Маневровый гусек



70°
35,3 + 2,9 m



25 - 79 m
0° / 22°



8,9 m



360°



160 t



EN 13000

m m	35,3 + 2,9													
	25 0°	31 0°	37 0°	43 0°	49 0°	55		61		67		73		79 0°
28,0	46,0	-	-	-	-	-	-	-	-	-	-	-	-	-
30,0	43,0	42,0	-	-	-	-	-	-	-	-	-	-	-	-
32,0	40,0	39,5	-	-	-	-	-	-	-	-	-	-	-	-
34,0	37,5	37,0	36,5	-	-	-	-	-	-	-	-	-	-	-
36,0	35,0	34,5	34,5	32,5	-	-	-	-	-	-	-	-	-	-
38,0	-	32,5	32,5	31,5	27,0	-	-	-	-	-	-	-	-	-
40,0	-	30,5	30,5	30,0	27,0	-	-	-	-	-	-	-	-	-
42,0	-	29,0	29,0	28,5	27,0	21,5	22,0	-	-	-	-	-	-	-
44,0	-	-	27,5	27,0	26,5	21,5	22,0	18,3	-	-	-	-	-	-
46,0	-	-	26,0	25,5	25,0	21,5	21,5	18,3	-	-	-	-	-	-
48,0	-	-	24,5	24,0	24,0	21,0	21,5	18,3	17,7	15,3	-	-	-	-
50,0	-	-	-	23,0	22,5	21,0	21,5	18,3	17,6	15,1	-	11,5	-	-
52,0	-	-	-	22,0	21,5	21,0	21,0	18,3	17,5	14,8	11,9	11,2	-	-
54,0	-	-	-	-	20,5	20,0	20,0	18,3	17,4	14,6	11,7	10,9	-	8,5
56,0	-	-	-	-	19,7	19,3	19,3	18,3	17,3	14,4	11,5	10,7	8,5	8,5
58,0	-	-	-	-	18,8	18,4	18,4	18,0	17,3	14,2	11,3	10,4	8,4	8,3
60,0	-	-	-	-	-	17,6	17,6	17,2	17,2	13,8	11,1	10,1	8,2	8,1
62,0	-	-	-	-	-	16,8	16,8	16,4	16,4	13,2	10,9	9,8	8,0	7,8
64,0	-	-	-	-	-	16,0	-	15,7	15,7	12,7	10,8	9,5	7,9	7,6
66,0	-	-	-	-	-	-	-	15,0	15,0	12,2	10,7	9,3	7,8	7,3
68,0	-	-	-	-	-	-	-	14,3	14,3	11,9	10,6	9,0	7,6	7,1
70,0	-	-	-	-	-	-	-	13,7	-	11,6	10,5	8,7	7,5	6,9
72,0	-	-	-	-	-	-	-	-	-	11,3	10,5	8,5	7,4	6,7
74,0	-	-	-	-	-	-	-	-	-	11,1	10,5	8,3	7,3	6,4
76,0	-	-	-	-	-	-	-	-	-	10,9	-	8,1	7,3	6,3
78,0	-	-	-	-	-	-	-	-	-	-	-	7,9	7,3	6,1
80,0	-	-	-	-	-	-	-	-	-	-	-	7,7	7,3	5,9
82,0	-	-	-	-	-	-	-	-	-	-	-	7,5	-	5,7
84,0	-	-	-	-	-	-	-	-	-	-	-	-	-	5,6
86,0	-	-	-	-	-	-	-	-	-	-	-	-	-	5,4



70°
45,0 + 2,9 m



25 - 79 m
0° / 22°



8,9 m



360°



160 t



EN 13000

m m	45,0 + 2,9													
	25 0°	31 0°	37 0°	43 0°	49 0°	55		61		67		73		79 0°
32,0	37,5	-	-	-	-	-	-	-	-	-	-	-	-	-
34,0	35,0	32,5	-	-	-	-	-	-	-	-	-	-	-	-
36,0	33,0	31,5	-	-	-	-	-	-	-	-	-	-	-	-
38,0	31,0	30,5	28,0	-	-	-	-	-	-	-	-	-	-	-
40,0	29,5	29,0	27,5	24,5	-	-	-	-	-	-	-	-	-	-
42,0	-	27,5	26,5	24,5	23,5	-	-	-	-	-	-	-	-	-
44,0	-	26,0	25,5	24,0	22,5	-	-	-	-	-	-	-	-	-
46,0	-	24,5	24,5	24,0	22,0	18,0	20,0	-	-	-	-	-	-	-
48,0	-	-	23,0	22,5	21,5	18,0	19,8	16,8	-	-	-	-	-	-
50,0	-	-	22,0	21,5	21,0	18,0	19,3	16,8	-	-	-	-	-	-
52,0	-	-	21,0	20,5	20,0	18,0	19,0	16,8	16,8	14,1	-	-	-	-
54,0	-	-	-	19,5	19,1	18,0	18,4	16,7	16,8	14,1	-	11,0	-	-
56,0	-	-	-	18,6	18,2	17,6	17,5	16,4	16,6	14,1	-	10,8	-	-
58,0	-	-	-	-	17,3	16,7	16,7	16,2	16,3	14,0	11,5	10,6	-	7,9
60,0	-	-	-	-	16,5	15,9	15,9	15,5	15,5	13,8	11,3	10,4	8,4	7,9
62,0	-	-	-	-	15,8	15,2	15,1	14,8	14,8	13,7	11,2	10,1	8,3	7,9
64,0	-	-	-	-	15,0	14,5	14,1	14,1	14,1	13,5	11,0	9,9	8,1	7,9
66,0	-	-	-	-	-	13,8	13,8	13,5	13,4	13,1	10,9	9,6	8,0	7,6
68,0	-	-	-	-	-	13,2	-	12,8	12,8	12,6	10,7	9,4	7,9	7,4
70,0	-	-	-	-	-	-	-	12,3	12,2	12,0	10,6	9,1	7,8	7,2
72,0	-	-	-	-	-	-	-	11,7	11,7	11,5	10,5	8,9	7,6	7,0
74,0	-	-	-	-	-	-	-	11,2	-	10,9	10,5	8,7	7,5	6,8
76,0	-	-	-	-	-	-	-	10,7	-	10,5	10,4	8,4	7,4	6,6
78,0	-	-	-	-	-	-	-	-	-	10,0	10,3	8,3	7,3	6,4
80,0	-	-	-	-	-	-	-	-	-	9,6	-	8,1	7,3	6,3
82,0	-	-	-	-	-	-	-	-	-	-	-	7,9	7,3	6,1
84,0	-	-	-	-	-	-	-	-	-	-	-	7,7	7,3	5,9
86,0	-	-	-	-	-	-	-	-	-	-	-	7,6	-	5,8
88,0	-	-	-	-	-	-	-	-	-	-	-	-	-	5,6
90,0	-	-	-	-	-	-	-	-	-	-	-	-	-	5,5

Load charts • Traglasten • Capacités de levage Capacidades • Capacità • Таблицы грузоподъемности

Mega-Wing-Lift

Luffing jib • Wippspitzenausleger • Volée variable • Plumín de angulación variable • Jib a volata variable • Маневровый гусек



70°
49,8 + 2,9 m



25 - 79 m
0° / 22°



8,9 m



360°



160 t



EN 13000

m m	49,8 + 2,9													
	25 0°	31 0°	37 0°	43 0°	49 0°	55		61		67		73		79 0°
34,0	33,5	-	-	-	-	-	-	-	-	-	-	-	-	-
36,0	32,0	28,0	-	-	-	-	-	-	-	-	-	-	-	-
38,0	30,5	27,5	-	-	-	-	-	-	-	-	-	-	-	-
40,0	29,0	26,5	24,0	-	-	-	-	-	-	-	-	-	-	-
42,0	27,0	25,5	23,5	21,0	-	-	-	-	-	-	-	-	-	-
44,0	-	25,0	23,0	20,5	-	-	-	-	-	-	-	-	-	-
46,0	-	23,5	22,5	20,0	19,3	-	-	-	-	-	-	-	-	-
48,0	-	22,5	21,5	19,7	19,0	16,0	16,9	-	-	-	-	-	-	-
50,0	-	-	20,5	19,2	18,6	16,0	16,7	-	-	-	-	-	-	-
52,0	-	-	19,7	18,6	18,2	16,0	16,4	14,7	-	-	-	-	-	-
54,0	-	-	18,7	17,8	17,9	16,0	16,1	14,4	14,6	13,0	-	-	-	-
56,0	-	-	-	17,0	17,4	15,7	15,8	14,2	14,3	12,8	-	-	-	-
58,0	-	-	-	16,2	16,6	15,4	15,5	13,9	14,1	12,6	-	10,3	-	-
60,0	-	-	-	-	15,8	15,2	15,2	13,7	13,9	12,4	11,3	10,2	-	-
62,0	-	-	-	-	15,1	14,5	14,4	13,5	13,7	12,1	11,2	10,0	-	7,6
64,0	-	-	-	-	14,4	13,8	13,8	13,3	13,4	11,9	11,0	9,8	8,2	7,6
66,0	-	-	-	-	13,7	13,2	13,1	12,7	12,8	11,7	10,9	9,7	8,1	7,6
68,0	-	-	-	-	-	12,6	12,5	12,1	12,2	11,4	10,8	9,5	7,9	7,5
70,0	-	-	-	-	-	12,0	-	11,6	11,6	11,1	10,7	9,2	7,8	7,3
72,0	-	-	-	-	-	-	-	11,0	11,1	10,7	10,5	9,0	7,7	7,1
74,0	-	-	-	-	-	-	-	10,5	10,6	10,3	10,4	8,8	7,6	6,9
76,0	-	-	-	-	-	-	-	10,1	-	9,8	10,1	8,6	7,4	6,7
78,0	-	-	-	-	-	-	-	9,6	-	9,4	9,6	8,4	7,4	6,5
80,0	-	-	-	-	-	-	-	-	-	9,0	9,2	8,2	7,3	6,4
82,0	-	-	-	-	-	-	-	-	-	8,5	-	8,0	7,2	6,2
84,0	-	-	-	-	-	-	-	-	-	-	-	7,8	7,2	6,0
86,0	-	-	-	-	-	-	-	-	-	-	-	7,6	7,2	5,9
88,0	-	-	-	-	-	-	-	-	-	-	-	7,2	-	5,7
90,0	-	-	-	-	-	-	-	-	-	-	-	-	-	5,6
92,0	-	-	-	-	-	-	-	-	-	-	-	-	-	5,4



70°
54,6 + 2,9 m



25 - 79 m
0° / 22°



8,9 m



360°



160 t



EN 13000

m m	54,6 + 2,9													
	25 0°	31 0°	37 0°	43 0°	49 0°	55		61		67		73		79 0°
36,0	26,5	-	-	-	-	-	-	-	-	-	-	-	-	-
38,0	24,0	22,5	-	-	-	-	-	-	-	-	-	-	-	-
40,0	23,0	21,5	-	-	-	-	-	-	-	-	-	-	-	-
42,0	22,0	20,0	19,1	-	-	-	-	-	-	-	-	-	-	-
44,0	20,5	19,2	18,2	17,0	-	-	-	-	-	-	-	-	-	-
46,0	-	18,3	17,3	16,2	-	-	-	-	-	-	-	-	-	-
48,0	-	17,3	16,5	15,4	16,0	-	-	-	-	-	-	-	-	-
50,0	-	16,5	15,7	14,7	15,3	-	-	-	-	-	-	-	-	-
52,0	-	-	14,9	14,0	14,7	13,7	14,2	-	-	-	-	-	-	-
54,0	-	-	14,2	13,1	13,9	12,3	13,0	11,6	-	-	-	-	-	-
56,0	-	-	13,5	12,1	12,8	11,8	11,9	11,2	11,4	10,5	-	-	-	-
58,0	-	-	-	11,3	12,1	11,3	11,4	10,7	10,9	10,1	-	-	-	-
60,0	-	-	-	10,7	11,6	10,9	11,0	10,3	10,5	9,8	-	9,1	-	-
62,0	-	-	-	-	11,1	10,4	10,5	9,9	10,1	9,4	9,7	8,7	-	-
64,0	-	-	-	-	10,6	10,0	10,1	9,5	9,7	9,1	9,3	8,4	-	6,9
66,0	-	-	-	-	10,1	9,6	9,6	9,1	9,3	8,7	9,0	8,1	8,2	6,9
68,0	-	-	-	-	9,7	9,2	9,2	8,8	8,9	8,4	8,6	7,9	8,0	6,9
70,0	-	-	-	-	-	8,8	8,8	8,4	8,6	8,0	8,3	7,6	7,8	6,8
72,0	-	-	-	-	-	8,4	-	8,1	8,2	7,7	7,9	7,3	7,5	6,5
74,0	-	-	-	-	-	-	-	7,7	7,9	7,4	7,6	7,0	7,2	6,3
76,0	-	-	-	-	-	-	-	7,4	7,6	7,1	7,3	6,7	7,0	6,0
78,0	-	-	-	-	-	-	-	7,0	-	6,8	7,0	6,4	6,7	5,8
80,0	-	-	-	-	-	-	-	6,7	-	6,5	6,7	6,1	6,4	5,6
82,0	-	-	-	-	-	-	-	-	-	6,2	6,5	5,9	6,1	5,3
84,0	-	-	-	-	-	-	-	-	-	5,9	-	5,6	5,8	5,1
86,0	-	-	-	-	-	-	-	-	-	-	-	5,4	5,6	4,9
88,0	-	-	-	-	-	-	-	-	-	-	-	5,1	5,4	4,6
90,0	-	-	-	-	-	-	-	-	-	-	-	4,9	-	4,4
92,0	-	-	-	-	-	-	-	-	-	-	-	-	-	4,2
94,0	-	-	-	-	-	-	-	-	-	-	-	-	-	4,0
96,0	-	-	-	-	-	-	-	-	-	-	-	-	-	3,8

Load charts • Traglasten • Capacités de levage Capacidades • Capacità • Таблицы грузоподъемности

Mega-Wing-Lift

Luffing jib • Wippspitzenausleger • Volée variable • Plumín de angulación variable • Jib a volata variable • Маневровый гусек



60°
35,3 + 2,9 m



25 - 79 m
0° / 22°



8,9 m



360°



160 t



EN 13000

m m	35,3 + 2,9													
	25 0°	31 0°	37 0°	43 0°	49 0°	55		61		67		73		79 0°
	0°	22°	0°	22°	0°	22°	0°	22°	0°	22°	0°	22°	0°	22°
36,0	31,5	-	-	-	-	-	-	-	-	-	-	-	-	-
38,0	29,5	-	-	-	-	-	-	-	-	-	-	-	-	-
40,0	28,0	27,5	-	-	-	-	-	-	-	-	-	-	-	-
42,0	26,5	26,0	-	-	-	-	-	-	-	-	-	-	-	-
44,0	-	24,5	24,0	-	-	-	-	-	-	-	-	-	-	-
46,0	-	23,0	23,0	-	-	-	-	-	-	-	-	-	-	-
48,0	-	22,0	21,5	21,0	-	-	-	-	-	-	-	-	-	-
50,0	-	-	20,5	19,9	-	-	-	-	-	-	-	-	-	-
52,0	-	-	19,5	18,9	18,5	-	-	-	-	-	-	-	-	-
54,0	-	-	18,5	18,0	17,5	-	-	-	-	-	-	-	-	-
56,0	-	-	-	17,1	16,7	16,0	16,0	-	-	-	-	-	-	-
58,0	-	-	-	16,3	15,9	15,2	15,2	-	-	-	-	-	-	-
60,0	-	-	-	-	15,1	14,5	14,5	14,0	-	-	-	-	-	-
62,0	-	-	-	-	14,4	13,8	13,8	13,3	13,3	-	-	-	-	-
64,0	-	-	-	-	13,7	13,1	13,1	12,7	12,7	12,4	-	-	-	-
66,0	-	-	-	-	-	12,5	12,5	12,1	12,1	11,8	11,1	-	-	-
68,0	-	-	-	-	-	11,9	11,9	11,5	11,5	11,2	10,9	9,8	-	-
70,0	-	-	-	-	-	11,4	-	11,0	11,0	10,7	10,8	9,5	-	-
72,0	-	-	-	-	-	-	-	10,5	10,5	10,2	10,4	9,2	7,7	7,0
74,0	-	-	-	-	-	-	-	10,0	10,0	9,7	10,0	9,0	7,6	7,0
76,0	-	-	-	-	-	-	-	9,5	-	9,3	9,5	8,7	7,5	6,8
78,0	-	-	-	-	-	-	-	-	-	8,8	9,1	8,5	7,4	6,6
80,0	-	-	-	-	-	-	-	-	-	8,4	8,6	8,2	7,3	6,4
82,0	-	-	-	-	-	-	-	-	-	8,0	-	7,9	7,2	6,2
84,0	-	-	-	-	-	-	-	-	-	-	-	7,5	7,2	6,0
86,0	-	-	-	-	-	-	-	-	-	-	-	7,1	7,1	5,9
88,0	-	-	-	-	-	-	-	-	-	-	-	6,8	-	5,7
90,0	-	-	-	-	-	-	-	-	-	-	-	-	-	5,6
92,0	-	-	-	-	-	-	-	-	-	-	-	-	-	5,4



60°
45,0 + 2,9 m



25 - 79 m
0° / 22°



8,9 m



360°



160 t



EN 13000

m m	45,0 + 2,9													
	25 0°	31 0°	37 0°	43 0°	49 0°	55		61		67		73		79 0°
	0°	22°	0°	22°	0°	22°	0°	22°	0°	22°	0°	22°	0°	22°
42,0	24,0	-	-	-	-	-	-	-	-	-	-	-	-	-
44,0	22,5	-	-	-	-	-	-	-	-	-	-	-	-	-
46,0	21,5	21,0	-	-	-	-	-	-	-	-	-	-	-	-
48,0	20,0	19,7	-	-	-	-	-	-	-	-	-	-	-	-
50,0	-	18,7	18,1	-	-	-	-	-	-	-	-	-	-	-
52,0	-	17,7	17,2	16,5	-	-	-	-	-	-	-	-	-	-
54,0	-	16,7	16,3	15,6	-	-	-	-	-	-	-	-	-	-
56,0	-	-	15,5	14,8	-	-	-	-	-	-	-	-	-	-
58,0	-	-	14,8	14,1	13,6	-	-	-	-	-	-	-	-	-
60,0	-	-	14,0	13,4	12,9	-	-	-	-	-	-	-	-	-
62,0	-	-	-	12,8	12,3	11,8	11,8	-	-	-	-	-	-	-
64,0	-	-	-	12,1	11,7	11,2	11,2	-	-	-	-	-	-	-
66,0	-	-	-	-	11,1	10,7	10,6	10,2	-	-	-	-	-	-
68,0	-	-	-	-	10,6	10,1	10,1	9,7	9,7	-	-	-	-	-
70,0	-	-	-	-	10,1	9,6	9,6	9,2	9,2	8,9	-	-	-	-
72,0	-	-	-	-	-	9,2	9,2	8,8	8,8	8,5	8,5	8,0	-	-
74,0	-	-	-	-	-	8,7	8,7	8,3	8,3	8,0	8,1	7,6	-	-
76,0	-	-	-	-	-	8,3	-	7,9	7,9	7,6	7,7	7,2	-	6,5
78,0	-	-	-	-	-	-	-	7,5	7,5	7,3	7,3	6,8	6,9	6,4
80,0	-	-	-	-	-	-	-	7,1	7,1	6,9	6,9	6,5	6,5	6,0
82,0	-	-	-	-	-	-	-	6,8	-	6,5	6,6	6,1	6,2	5,7
84,0	-	-	-	-	-	-	-	-	-	6,2	6,2	5,8	5,8	5,3
86,0	-	-	-	-	-	-	-	-	-	5,9	5,9	5,5	5,5	5,0
88,0	-	-	-	-	-	-	-	-	-	5,5	-	5,2	5,2	4,7
90,0	-	-	-	-	-	-	-	-	-	-	-	4,9	4,9	4,5
92,0	-	-	-	-	-	-	-	-	-	-	-	4,6	4,7	4,2
94,0	-	-	-	-	-	-	-	-	-	-	-	-	-	3,9
96,0	-	-	-	-	-	-	-	-	-	-	-	-	-	3,7
98,0	-	-	-	-	-	-	-	-	-	-	-	-	-	3,4

Load charts • Traglasten • Capacités de levage Capacidades • Capacità • Таблицы грузоподъемности

Mega-Wing-Lift

Luffing jib • Wippspitzenausleger • Volée variable • Plumín de angulación variable • Jib a volata variable • Маневровый гусек



60°
49,8 + 2,9 m



25 - 79 m
0° / 22°



8,9 m



360°



160 t



EN 13000

m m	49,8 + 2,9													
	25 0°	31 0°	37 0°	43 0°	49 0°	55		61		67		73		79 0°
44,0	21,5	-	-	-	-	-	-	-	-	-	-	-	-	-
46,0	20,5	-	-	-	-	-	-	-	-	-	-	-	-	-
48,0	19,3	18,7	-	-	-	-	-	-	-	-	-	-	-	-
50,0	18,3	17,7	-	-	-	-	-	-	-	-	-	-	-	-
52,0	-	16,8	16,2	-	-	-	-	-	-	-	-	-	-	-
54,0	-	15,9	15,4	-	-	-	-	-	-	-	-	-	-	-
56,0	-	15,1	14,6	13,9	-	-	-	-	-	-	-	-	-	-
58,0	-	-	13,9	13,2	-	-	-	-	-	-	-	-	-	-
60,0	-	-	13,2	12,5	12,3	-	-	-	-	-	-	-	-	-
62,0	-	-	12,5	11,9	11,7	-	-	-	-	-	-	-	-	-
64,0	-	-	-	11,3	11,1	10,4	-	-	-	-	-	-	-	-
66,0	-	-	-	10,8	10,5	9,8	9,8	-	-	-	-	-	-	-
68,0	-	-	-	10,2	10,0	9,3	9,3	8,9	-	-	-	-	-	-
70,0	-	-	-	-	9,5	8,9	8,9	8,4	8,4	-	-	-	-	-
72,0	-	-	-	-	9,1	8,4	8,4	8,0	8,0	7,6	-	-	-	-
74,0	-	-	-	-	8,6	8,0	8,0	7,6	7,6	7,2	-	-	-	-
76,0	-	-	-	-	-	7,6	7,6	7,2	7,2	6,8	6,8	6,3	-	-
78,0	-	-	-	-	-	7,2	-	6,8	6,8	6,5	6,5	6,0	-	-
80,0	-	-	-	-	-	-	-	6,4	6,5	6,1	6,1	5,6	-	4,8
82,0	-	-	-	-	-	-	-	6,1	6,1	5,8	5,8	5,3	5,4	4,8
84,0	-	-	-	-	-	-	-	5,8	-	5,5	5,5	5,0	5,0	4,5
86,0	-	-	-	-	-	-	-	5,4	-	5,2	5,2	4,7	4,8	4,2
88,0	-	-	-	-	-	-	-	-	-	4,9	4,9	4,4	4,5	3,9
90,0	-	-	-	-	-	-	-	-	-	4,6	-	4,1	4,2	3,7
92,0	-	-	-	-	-	-	-	-	-	-	-	3,9	3,9	3,4
94,0	-	-	-	-	-	-	-	-	-	-	-	3,6	3,7	3,2
96,0	-	-	-	-	-	-	-	-	-	-	-	3,4	-	2,9
98,0	-	-	-	-	-	-	-	-	-	-	-	-	-	2,7
100,0	-	-	-	-	-	-	-	-	-	-	-	-	-	2,5
102,0	-	-	-	-	-	-	-	-	-	-	-	-	-	2,3



60°
54,6 + 2,9 m



25 - 79 m
0° / 22°



8,9 m



360°



160 t



































EN 13000

m m	54,6 + 2,9													
	25 0°	31 0°	37 0°	43 0°	49 0°	55		61		67		73		79 0°
48,0	18,4	-	-	-	-	-	-	-	-	-	-	-	-	-
50,0	17,4	-	-	-	-	-	-	-	-	-	-	-	-	-
52,0	16,4	15,7	-	-	-	-	-	-	-	-	-	-	-	-
54,0	15,5	15,0	-	-	-	-	-	-	-	-	-	-	-	-
56,0	-	14,2	13,3	-	-	-	-	-	-	-	-	-	-	-
58,0	-	13,5	12,6	10,8	-	-	-	-	-	-	-	-	-	-
60,0	-	-	11,4	10,4	-	-	-	-	-	-	-	-	-	-
62,0	-	-	10,9	9,9	-	-	-	-	-	-	-	-	-	-
64,0	-	-	-	9,5	10,2	-	-	-	-	-	-	-	-	-
66,0	-	-	-	9,1	9,7	-	-	-	-	-	-	-	-	-
68,0	-	-	-	8,6	9,2	8,5	8,5	-	-	-	-	-	-	-
70,0	-	-	-	8,2	8,8	8,1	8,1	-	-	-	-	-	-	-
72,0	-	-	-	-	8,3	7,7	7,6	7,2	-	-	-	-	-	-
74,0	-	-	-	-	7,9	7,3	7,2	6,8	6,8	-	-	-	-	-
76,0	-	-	-	-	7,5	6,9	6,9	6,4	6,4	6,0	-	-	-	-
78,0	-	-	-	-	-	6,5	6,5	6,1	6,1	5,7	-	5,1	-	-
80,0	-	-	-	-	-	6,1	6,1	5,7	5,7	5,4	5,4	4,8	-	-
82,0	-	-	-	-	-	5,8	-	5,4	5,4	5,0	5,1	4,5	-	-
84,0	-	-	-	-	-	-	-	5,1	5,1	4,7	4,8	4,2	4,3	3,5
86,0	-	-	-	-	-	-	-	4,8	4,8	4,5	4,5	3,9	4,0	3,4
88,0	-	-	-	-	-	-	-	4,5	-	4,2	4,2	3,6	3,7	3,1
90,0	-	-	-	-	-	-	-	-	-	3,9	3,9	3,4	3,5	2,9
92,0	-	-	-	-	-	-	-	-	-	3,7	3,7	3,1	3,2	2,7
94,0	-	-	-	-	-	-	-	-	-	3,4	-	2,9	3,0	2,4
96,0	-	-	-	-	-	-	-	-	-	-	-	2,7	2,8	2,2
98,0	-	-	-	-	-	-	-	-	-	-	-	2,5	2,5	2,0
100,0	-	-	-	-	-	-	-	-	-	-	-	-	-	1,8
102,0	-	-	-	-	-	-	-	-	-	-	-	-	-	1,6
104,0	-	-	-	-	-	-	-	-	-	-	-	-	-	1,4

Notes • Hinweise • Notes • Notas • Note • Примечания

Symbols • Symbolerklärung • Glossaire des symboles • Glosario de simbolos • Glossario dei simboli • Символы

	Axles Achsen Ponts Ejes Assali Оси		Crane functions Kranbewegungen Mouvements de la grue Funciones de la grúa Funzioni della gru Функции крана		Hookblock / Capacity Hakenflasche / Traglast Moufle / Force de levage Gancho / Capacidad Gancio / Capacità Крюковой блок / Грузоподъемность		Speed Geschwindigkeit Vitesse Velocidad Velocità Скорость
	Axle load Achslast Charge à l'essieu Carga por eje Carico sugli assi Нагрузка на ось		Crane travel Fahrstellung Déplacement de la grue Grúa en traslado Traslazione gru Перемещение крана		Hydraulic system Hydrauliksystem Circuit hydraulique Sistema hidráulico Impianto idraulico Гидравлическая система		Suspension Federung Suspension Suspensión Sospensioni Подвеска
	Boom Ausleger Flèche Pluma Braccio Стрела		Drive/Steer Antrieb/Lenkung Direction/Déplacement Tracción/Dirección Trazione/Sterzo Ведущие/Управляемые оси		Lattice extension Gitterspitze Extension treillis Extensión de celosía Falcone tralicciato Гусек		Transmission / Gear Getriebe / Gang Boîte de vitesses / Rapport Transmisión / Cambio Trasmissione / Cambio Трансмиссия / передача
	Boom elevation Wippwerk Relevage Elevacion de pluma Elevazione braccio Подъем стрелы		Electrical system Elektrische Anlage Circuit électrique Sistema eléctrico Impianto elettrico Электросистема		Lattice extension (luffing) Gitterspitze (wippbar) Extension treillis (volée variable) Extensión de celosía (angulable hidráulicamente) Falcone tralicciato (inclinabile) Гусек (с изменением вылета)		Travel speed Fahrtgeschwindigkeit Vitesse de déplacement Velocidad de desplazamiento Velocità di traslazione Скорость движения
	Boom telescoping Teleskopieren Télescopeage de flèche Telescopaje de pluma Lunghezza braccio Выдвижение стрелы		Engine Motor Moteur Motor Motore Двигатель		Luffing Jib Wippspitzenausleger Volée variable Plumín angulable Falcone a volata variabile Маневровый гусек		Tyres Bereifung Pneumáticos Neumáticos Pneumatici Шины
	Brakes Bremsen Freins Frenos Freni Тормоза		Free on wheels Freistehend Sur pneus Sobre neumáticos Su gomma Свободные внутренние колеса		Low range Kriechgang Gamme basse Marchas cortas Fuoristrada Низкий диапазон		
	Cab Kabine Cabine Cabina Cabina Кабина		Gradeability Steigfähigkeit Aptitude en pente Superacion de pendientes Pendenza superabile Преодолеваемый уклон		Outriggers Abstützung Calage Estabilizadores Stabilizzatori Выносные опоры		
	Carrier frame Chassis-Rahmen Châssis porteur Bastidor Telaio Рама тягача		Main hoist Haupthubwerk Treuil principal Cabrestante principal Argano principale Лебедка основного подъема		Radius Ausladung Portée Radio Raggio Вылет		
	Counterweight Gegengewicht Contrepoids Contrapeso Contrappeso Противовес		Auxiliary hoist Hilfshubwerk Treuil auxiliaire Cabrestante auxiliar Argano secondario Лебедка вспомогательного подъема		Slewing/Working range Drehwerk/Arbeitsbereich Orientation/Rayon d'opération Giro/Gama de trabajo Rotazione/Area di lavoro Поворот/ Рабочий диапазон		

Manitowoc Cranes

Regional headquarters

Manitowoc - Americas

Manitowoc, Wisconsin, USA

Tel: +1 920 684 6621

Fax: +1 920 683 6277

Shady Grove, Pennsylvania, USA

Tel: +1 717 597 8121

Fax: +1 717 597 4062

Manitowoc - Europe, Middle East, Africa

Ecully, France

Tel: +33 (0)4 72 18 20 20

Fax: +33 (0)4 72 18 20 00

China

Shanghai, China

Tel: +86 21 6457 0066

Fax: +86 21 6457 4955

Greater Asia-Pacific

Singapore

Tel: +65 6264 1188

Fax: +65 6862 4040

Regional offices

Americas

Brazil

Alphaville

Mexico

Monterrey

Chile

Santiago

Europe, Middle East, Africa

Czech Republic

Netvorice

France

Baudemont

Cergy

Decines

Germany

Langenfeld

Hungary

Budapest

Italy

Lainate

Netherlands

Breda

Poland

Warsaw

Portugal

Baltar

Russia

Moscow

U.A.E.

Dubai

U.K.

Buckingham

China

Beijing

Chengdu

Guangzhou

Xian

Greater Asia - Pacific

Australia

Adelaide

Brisbane

Melbourne

Sydney

India

Calcutta

Chennai

Delhi

Hyderabad

Pune

Korea

Seoul

Philippines

Makati City

Singapore

Factories

Brazil

Alphaville

China

TaiAn

Zhangjiagang

France

Charlieu

Moulins

Germany

Wilhelmshaven

India

Pune

Italy

Niella Tanaro

Portugal

Baltar

Fânzeres

Slovakia

Saris

U.S.A.

Manitowoc

Port Washington

Shady Grove

This document is non-contractual. Constant improvement and engineering progress make it necessary that we reserve the right to make specification, equipment, and price changes without notice. Illustrations shown may include optional equipment and accessories and may not include all standard equipment.

Die Angaben in diesem Dokument erfolgen ohne Gewähr. Wir verbessern unsere Produkte ständig und integrieren den technischen Fortschritt. Aus diesem Grund behalten wir uns das Recht vor, die technischen Daten, die Ausstattungsdetails und die Preise unserer Maschinen ohne Vorankündigung zu ändern.

Ce document est non-contractuel. Du fait de sa politique d'amélioration constante de ses produits liée au progrès technique, la Société se réserve le droit de procéder sans préavis à des changements de spécifications, d'équipement ou de prix. Les illustrations peuvent comporter des équipements ou accessoires optionnels ou ne pas comporter des équipements standards.

Este documento no es contractual. El perfeccionamiento constante y el avance tecnológico hacen necesario que la empresa se reserve el derecho de efectuar cambios en las especificaciones, equipo y precios sin previo aviso. En las ilustraciones se puede incluir equipo y accesorios opcionales y es posible que no se muestre el equipo normal.

Documento non contrattuale. In considerazione della sua politica di costante miglioramento dei prodotti connesso al progresso tecnico, la Società si riserva il diritto di modificare senza preavviso specifiche, equipaggiamenti o prezzi. Le illustrazioni possono contenere equipaggiamenti o accessori optional o non contenere equipaggiamenti standard.

Данный документ не является контрактным. Принимая во внимание необходимость постоянного совершенствования и модернизации мы оставляем за собой право изменять спецификации, конструкции и стоимость без предварительного уведомления. Приведенные иллюстрации могут содержать дополнительные компоненты и принадлежности, не входящие в стандартный комплект поставки оборудования.