

**KOBELCO**

# HYDRAULIC CRAWLER CRANE ***CKE1800***

Model: CKE1800-1F

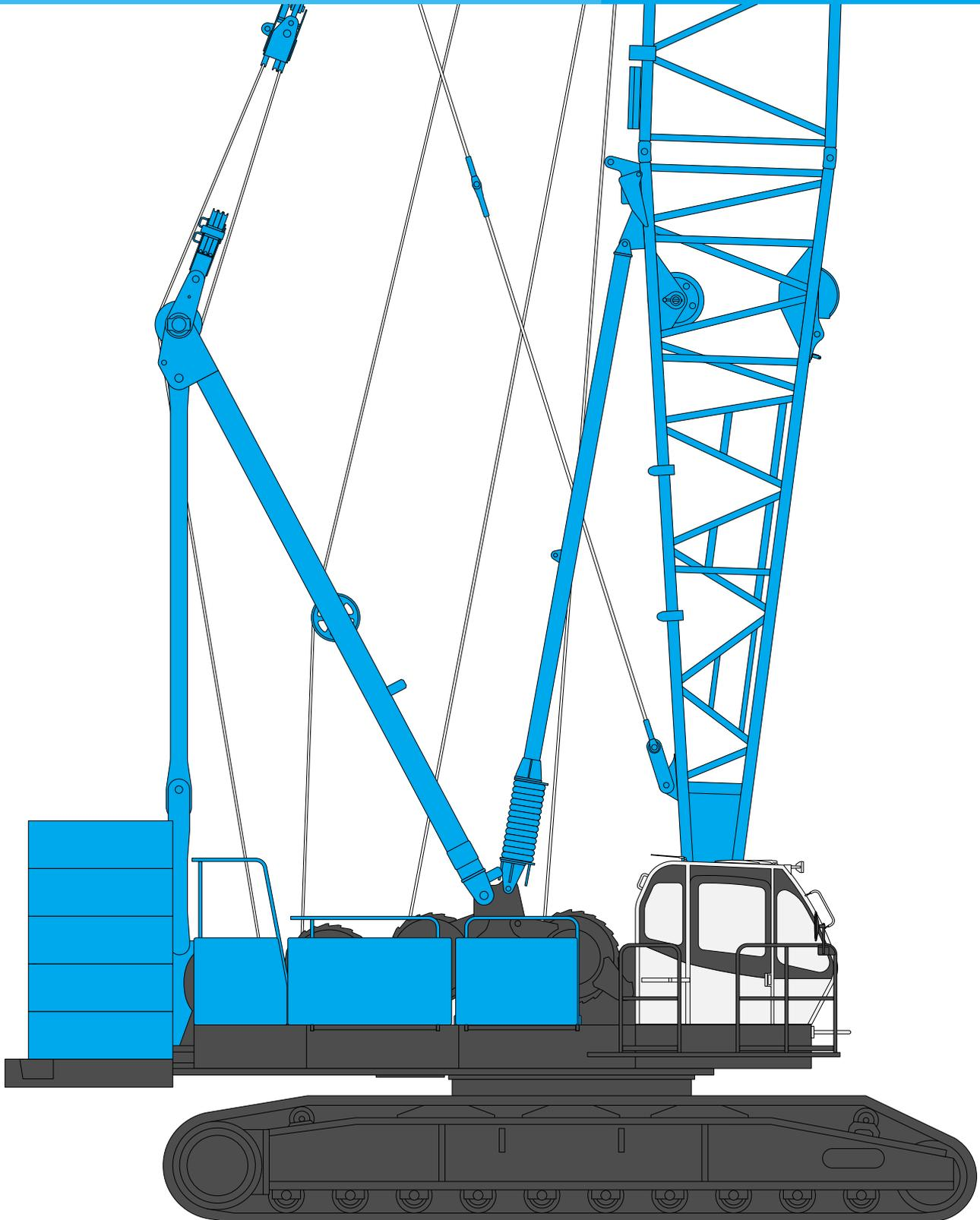

**Max. Lifting Capacity: 180 ton x 3.75 m**  
**Max. Crane Boom Length: 85.3 m**  
**Max. Long Boom Length: 85.3 m**  
**Max. Fixed Jib Combination: 73.2 m + 30.5 m**  
**Max. Luffing Jib Combination: 54.9 m + 51.8 m**

# CONFIGURATION

## Crane Boom

Max. Lifting Capacity:  
160 metric ton x 4.4 m  
Max. Boom Length:  
85.3 m



## Long Boom

Max. Lifting Capacity:  
40.1 metric ton x 12.0 m  
Max. Boom Length:  
85.3 m



## Heavy Duty Crane Boom

Max. Lifting Capacity:  
180 metric ton x 3.75 m  
Max. Boom Length:  
42.7 m



## Luffing Boom

Max. Lifting Capacity:  
110 metric ton x 5.2 m  
Max. Boom Length:  
54.9 m

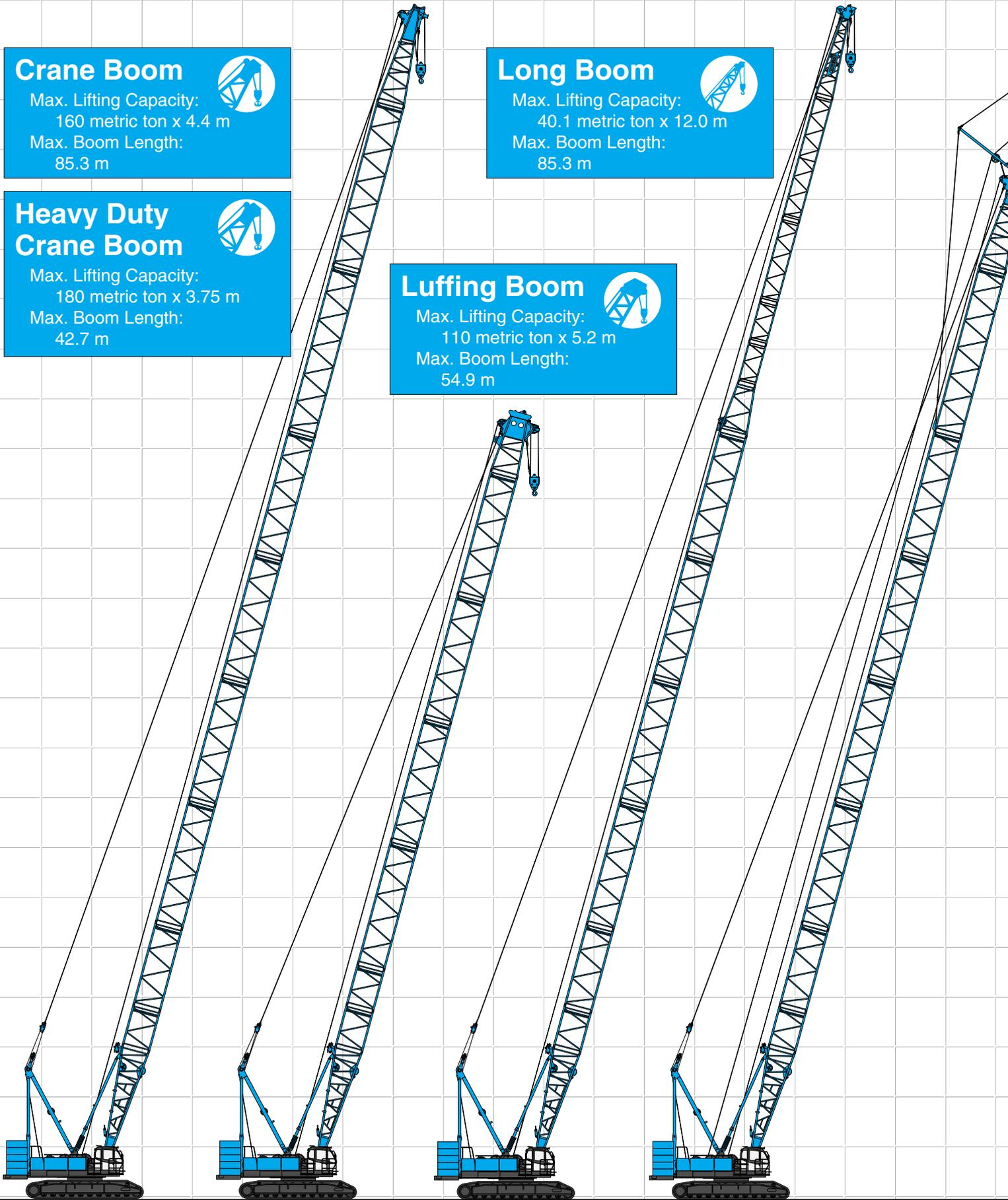

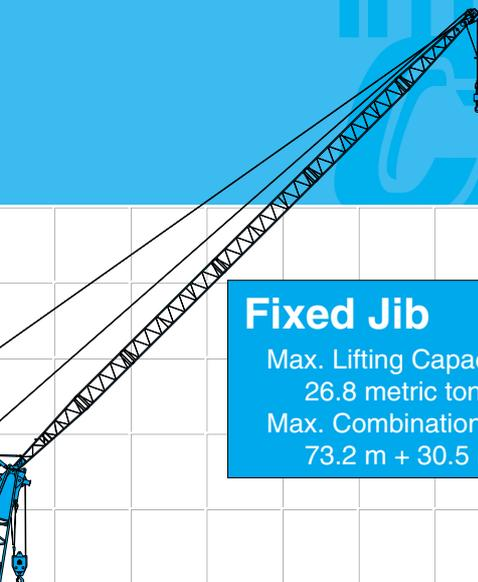

**Fixed Jib**  
 Max. Lifting Capacity:  
 26.8 metric ton x 15.2 m  
 Max. Combination:  
 73.2 m + 30.5 m

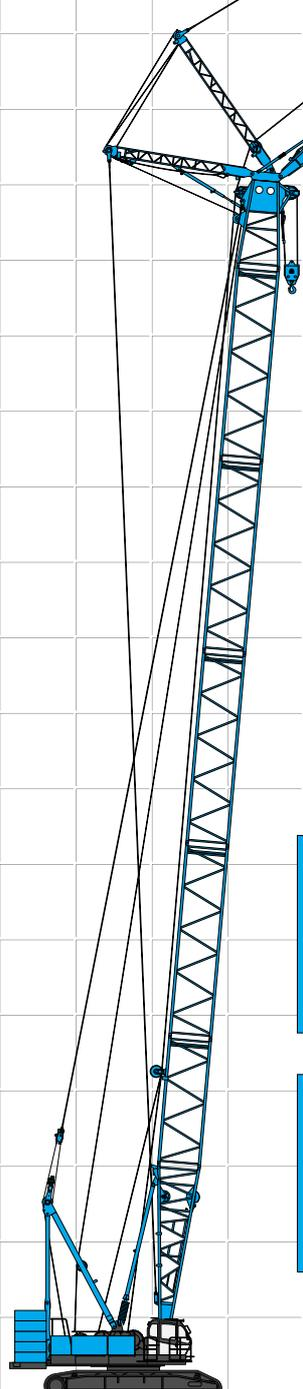

**Luffing Jib**  
 Max. Lifting Capacity:  
 48.6 metric ton x 9.14 m  
 Max. Combination:  
 54.9 m + 51.8 m

**Luffing Boom with Luffing Jib**  
 Max. Lifting Capacity:  
 71.5 metric ton x 9.0 m

## CONTENTS

- Configuration ..... 1
- Specifications ..... 3
- General Dimensions ..... 5
- Boom and Jib Arrangements**
- Crane Boom Arrangements ..... 7
- Fixed Jib Arrangements ..... 8
- Long Boom Arrangements ..... 8
- Luffing Boom Arrangements for Luffing ..... 9
- Luffing Boom Arrangements for Crane ..... 9
- Luffing Jib Arrangements ..... 10
- Working Ranges and Lifting Capacities**
- Crane Boom Working Ranges ..... 12
- Crane Boom Lifting Capacity ..... 13
- Luffing Boom Working Ranges ..... 14
- Luffing Boom Lifting Capacity ..... 15
- Long Boom Working Ranges ..... 16
- Long Boom Lifting Capacity ..... 17
- Fixed Jib Working Ranges ..... 18
- Fixed Jib Lifting capacities ..... 19
- Luffing Jib Working Ranges ..... 21
- Luffing Jib Lifting Capacities ..... 23
- Luffing Boom Lifting Capacities with Luffing Jib ..... 30
- Parts and Attachments ..... 31
- Transportation Plan ..... 35

# SPECIFICATIONS



## Power Plant

**Model:** Hino diesel engine P11C-UN

**Type:** Water-cooled, direct fuel injection, with turbocharger  
Complies with NRMM (Europe) Tier III and USA EPA Tier III

**Displacement:** 10.520 liters

**Rated Power:** 247 kW/ 2,000 min<sup>-1</sup> {rpm} (ISO)

**Max. torque:** 1,300 N·m/1,500 min<sup>-1</sup>

**Cooling system:** Liquid, re-circulating bypass

**Starter:** 24V / 6.0 kW

**Radiator:** Corrugated type core, thermostatically controlled

**Air cleaner:** Dry type with replaceable paper element

**Throttle:** Electric throttle control, twist grip type

**Fuel filter:** Replaceable paper element.

**Batteries:** Two 12 V, 170 Ah/20 HR capacity batteries, series connected.

**Fuel tank capacity:** 400 liters



## Hydraulic System

Four variable displacement piston pumps are driven by heavy-duty pump drive. Two of variable displacement pumps are used in the main hook hoist circuit, auxiliary hook hoist circuit, third hoist circuit and each propel circuit. One of the other two pumps is used in the boom hoist circuit, and the other is used in the swing circuit.

**Control:** Full-flow hydraulic control system for infinitely variable pressure to front and rear drums, boom hoist brakes and clutches. Controls respond instantly to the touch, delivering smooth function operation.

**Cooling:** Oil-to-air heat exchanger (plate-fin type)

**Filtration:** Full-flow and bypass type with replaceable element

**Electrical system:** All wiring corded for easy servicing, individual fused branch circuits.

**Max. relief valve pressure:**

**Load hoist, boom hoist and propel system:**

31.9 MPa {325 kgf/cm<sup>2</sup>}

**Swing system:** 27.5 MPa {280 kgf/cm<sup>2</sup>}

**Control system:** 7.0 MPa {71.3 kgf/cm<sup>2</sup>}

**Reservoir capacity:** 550 liters



## Boom Hoisting System

Powered by a hydraulic motor through a planetary reducer.

**Brake:** A spring-set, hydraulically released multiple-disc brake is mounted on the boom hoist motor and operated through a counter-balance valve.

**Drum lock:** External ratchet for locking drum.

**Drum:** Double drum, grooved for 22 mm dia. wire rope.

**Line speed:** Double line on first drum layer

**Hoisting/Lowering:** 54 m/min

**Diameter of wire ropes**

**Boom guy line:** 30 mm

**Boom hoist reeving:** 16 parts of 22 mm dia. high strength wire rope

**Boom backstops:** Telescopic type with spring bumper  
Required for all boom lengths



## Load Hoist System

Front and rear drums for load hoist powered by a hydraulic variable plunger motors, driven through planetary reducers.

**Negative Brake:** A spring-set, hydraulically released multiple-disc brake is mounted on the hoist motor and operated through a counter-balance valve. (Positive free fall brake is optional item.)

**Drum lock:** External ratchet for locking drum

**Drums:**

**Front drum:**

617.4 mm P.C.D. x 833.7 mm Lg. wide drum, grooved for 25.4 mm wire rope. Rope capacity is 430 m working length and 510 m storage length.

**Rear drum:**

617.1 mm P.C.D. x 833.7 mm Lg. wide drum, grooved for 25.4 mm wire rope. Rope capacity is 335 m working length and 510 m storage length.

Note: Rope lengths listed above denote drum capacity and may differ from actual rope lengths supplied when machinery is shipped.

**Line speed:** Single line on the first drum layer

**Hoisting/Lowering:** 100 m/min

**Line Pull (Single-line):**

**Rated line pull:** 132 kN {13.5 tf}



## Swing System

Swing unit is powered by hydraulic motor driving spur gears through planetary reducers (2 sets), the swing system provides 360° rotation.

**Swing parking brakes:** A spring-set, hydraulically released multiple-disc brake is mounted on swing motor.

**Swing circle:** Single-row ball bearing with an integral internally cut swing gear.

**Swing lock:** Manually, four position lock for transportation

**Swing speed:** 2.6 min<sup>-1</sup> {rpm}



## Upper Structure

Torsion-free precision machined upper frame. All components are located clearly and service friendly. Engine with low noise level. Complies with European Noise Regulations.

**Counterweight:** 60.0 ton

# HYDRAULIC CRAWLER CRANE CKE1800



## Cab & Control

Totally enclosed, full vision cab with safety glass, fully adjustable, high backed seat with a head-rest and armrests, and intermittent wiper and window washer (skylight and front window).

### Cab fittings:

Air conditioner, convenient compartment (for tool), cup holder, ashtray, cigarette lighter, sun visor, roof blind, tinted glass, floor mat, foot-rest, shoe tray

### Controls:

Four adjustable levers for front drum, rear drum, boom drum and swing controls, and boom hoist pedal.



## Lower Structure

Steel-welded carbody with axles. Crawler assemblies are designed with quick disconnect feature for individual removal as a unit from axles. Crawler belt tension is maintained by hydraulic jack force on the track-adjusting bearing block.

**Carbody weight:** 20.0 ton

**Crawler drive:** Independent hydraulic propel drive is built into each crawler side frame. Each drive consists of a hydraulic motor propelling a driving tumbler through a planetary gear box. Hydraulic motor and gear box are built into the crawler side frame within the shoe width.

**Crawler brakes:** Spring-set, hydraulically released parking brakes are built into each propel drive.

**Steering mechanism:** A hydraulic propel system provides both skid steering (driving one track only) and counter-rotating steering (driving each track in opposite directions).

**Track rollers:** Sealed track rollers for maintenance-free operation.

**Shoes (flat):** 64 shoes, 1,070 mm wide each crawler

**Max. travel speed:** 1.1/0.7 km/h

**Max. gradeability:** 30%



## Weight

Including upper and lower machine, 60.0 ton counterweight and 20.0 ton carbody weight, basic boom (or basic boom + basic jib), hook, and other accessories.

Specification	Weight	Ground pressure
<b>Crane boom</b>	Approx. 164 ton,	103 kPa {1.06 kgf/cm <sup>2</sup> }
<b>Luffing jib</b>	Approx. 171 ton,	95 kPa {0.97 kgf/cm <sup>2</sup> }



## Attachment

### Boom and Jib:

Welded lattice construction using tubular, high-tensile steel chords with pin connections between sections.

Boom and Jib Length

	Min. Length (Min. Combination)	Max. Length (Max. Combination)
Crane Boom	15.2 m	85.3 m
Luffing Boom	15.2 m	54.9 m
Long Boom	61.0 m	85.3 m
Fixed Jib	24.4 m + 12.2 m	73.2 m + 30.5 m
Luffing Jib	21.3 m + 21.3 m	54.9 m + 51.8 m

## Main Specifications (Model: CKE 1800-1F)

Heavy Duty Crane Boom	
Max. Lifting Capacity	180 t/3.75 m
Max. Length	42.7 m
Crane Boom	
Max. Lifting Capacity	160 t/4.4 m
Max. Length	85.3 m
Luffing Boom	
Max. Lifting Capacity	110 t/5.2 m
Max. Length	54.9 m
Long Boom	
Max. Lifting Capacity	40.1 t/12.0 m
Max. Length	85.3 m
Fixed Jib	
Max. Lifting Capacity	26.8 t/15.2 m
Max. Length	30.5 m
Max. Combination	73.2 m + 30.5 m
Luffing Jib	
Max. Lifting Capacity	48.6 t/9.14 m
Jib Length	21.3 m ~ 51.8 m
Max. Combination	54.9 m + 51.8 m
Luffing Angle	60° ~ 88°
Working Speed	
Swing Speed	2.6 min <sup>-1</sup> {rpm}
Travel Speed	1.1/0.7 km/h

Power Plant	
Model	Hino P11C-UN
Engine Output	247 kW/2,000 min <sup>-1</sup> {rpm}
Fuel Tank Capacity	400 liters
Main & Aux. Winch	
Max. Line Speed	100 m/min (1st layer)
Rated Line Pull	132 kN {13.5 tf}
Wire Rope Diameter	25.4 mm
Wire Rope Length	430 m (Main) 335 m (Aux.)
Brake Type	Spring set hydraulically released (Negative)
Free Fall Brake	Wet-type multiple disc brake (Optional)
Hydraulic System	
Pumps	4 variable displacement
Max. Pressure	31.9 MPa {325 kgf/cm <sup>2</sup> }
Hydraulic Tank Capacity	550 liters
Self Erection Device	
	Standard
Weight	
Operating Weight*	Approx. 164 t
Ground Pressure*	103 kPa {1.06 kgf/cm <sup>2</sup> }
Counterweight	60.0 t (Upper), 20.0 t (Lower)
Transportation Weight**	Approx. 44.0 t

\* Including upper and lower machine, 60.0 ton counterweight, 20.0 ton carbody weight, basic boom, hook, and other accessories.

\*\* Base machine with boom base, trans-lifter, main and aux. winches (non-freefall) including wire rope, self removal device.

Units are SI units. { } indicates conventional units.

# GENERAL DIMENSIONS

## Crane Boom

(Unit: mm)

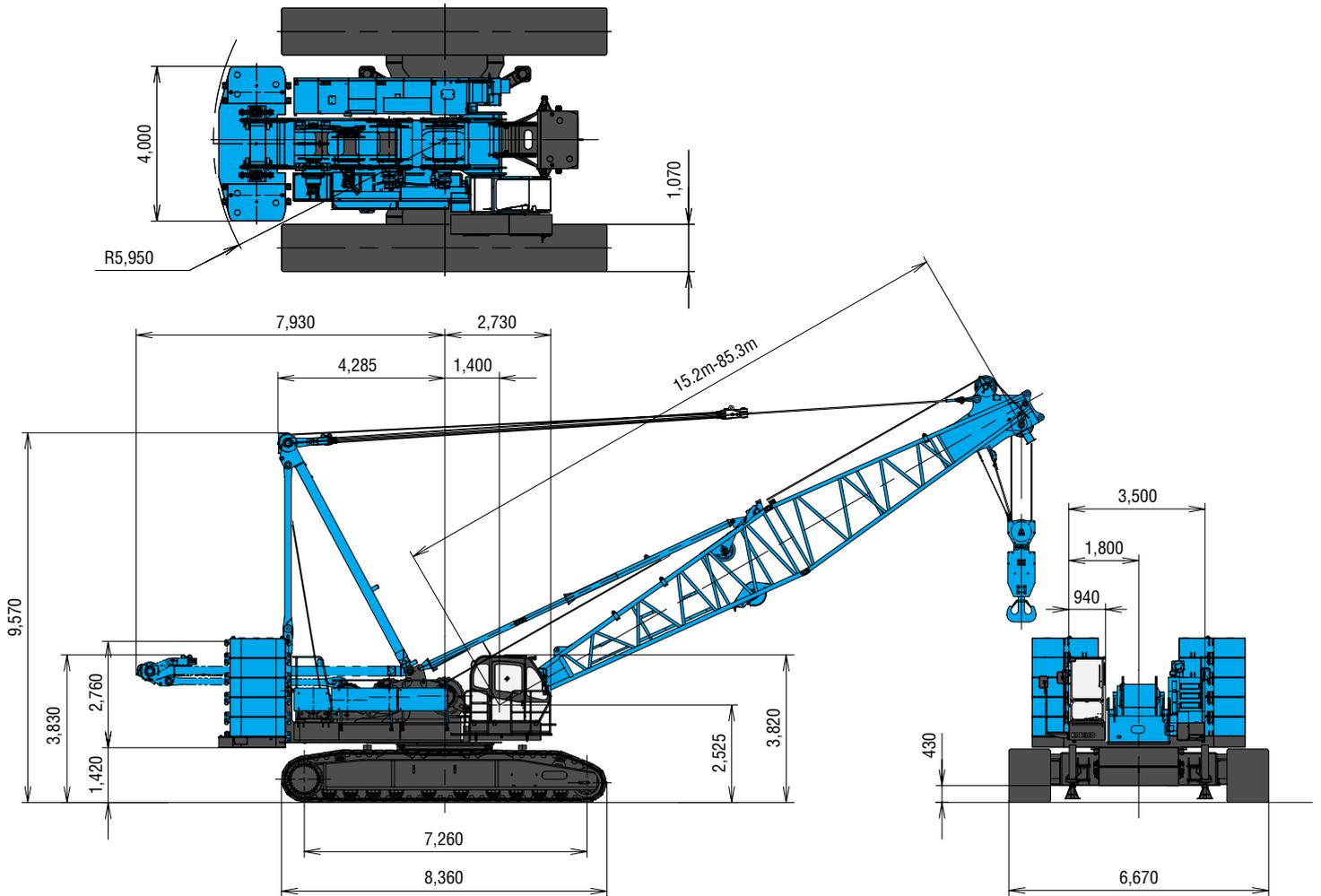

## Limit of Hook Lifting

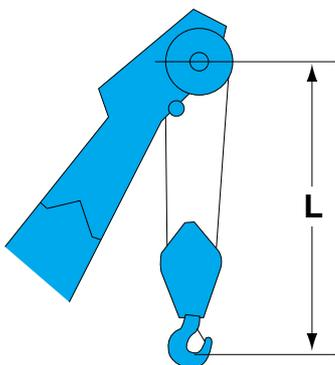

Hook	L
180 t/160 t hook	5.2 m
110 t hook	5.1 m
70 t hook	4.9 m
35 t hook	4.7 m

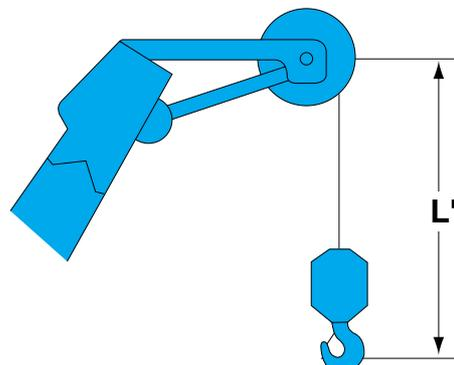

Hook	L'
13.5 t ball hook	3.5 m

# HYDRAULIC CRAWLER CRANE CKE1800

## Luffing Jib

(Unit: mm)

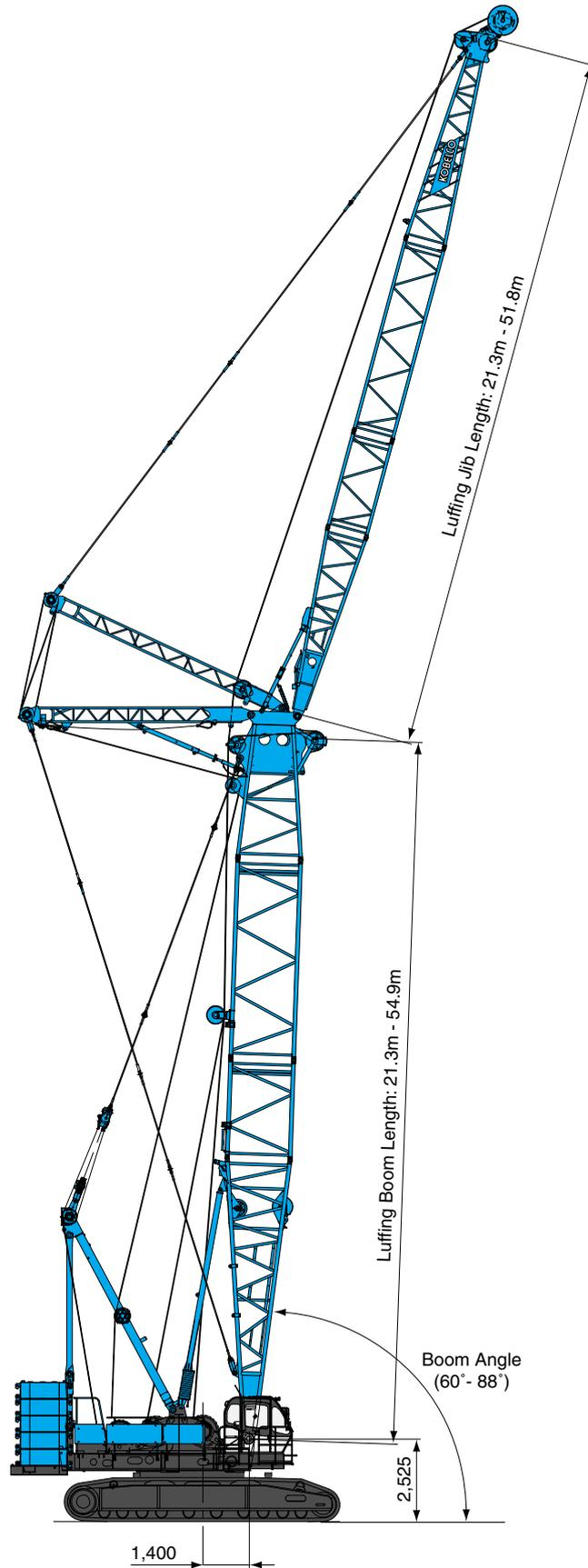

# BOOM AND JIB ARRANGEMENTS

## Crane Boom Arrangements

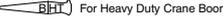
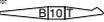
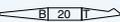
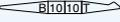
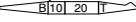
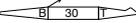
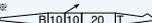
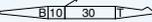
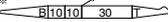
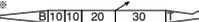
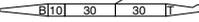
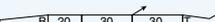
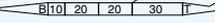
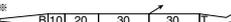
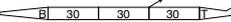
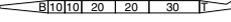
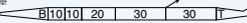
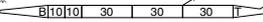
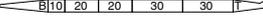
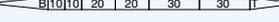
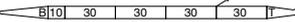
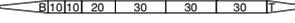
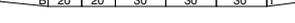
Boom length m (ft)	Boom arrangement
12.2 (40)	 For Heavy Duty Crane Boom
15.2 (50)	
18.3 (60)	* 
21.3 (70)	 * 
24.4 (80)	*  
27.4 (90)	*  
30.5 (100)	 * 
33.5 (110)	*  
36.6 (120)	*  
39.6 (130)	 *  * 
42.7 (140)	*   * 
45.7 (150)	 *  
48.8 (160)	 *  * 
51.8 (170)	*   * 
54.9 (180)	 *  

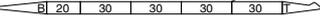
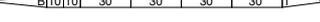
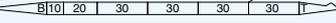
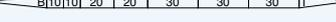
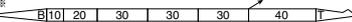
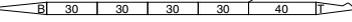
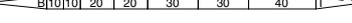
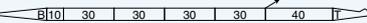
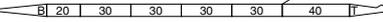
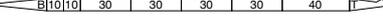
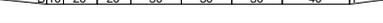
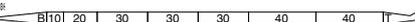
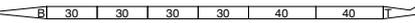
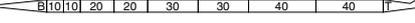
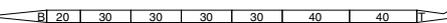
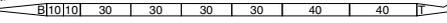
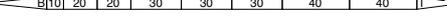
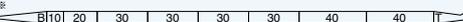
Boom length m (ft)	Boom arrangement
57.9 (190)	 *  * 
61.0 (200)	*  * 
64.0 (210)	*   * 
67.1 (220)	 *  
70.1 (230)	 *  * 
73.2 (240)	*  * 
76.2 (250)	*   * 
79.3 (260)	 *  
82.3 (270)	 *  * 
85.3 (280)	* 

Symbol	Boom Length	Remarks
	8.5 m	Boom Base
	3.7 m	Heavy Duty Crane Boom Top
	6.7 m	Boom Top
	3.0 m	Insert Boom
	6.1 m	Insert Boom
	9.1 m	Insert Boom
	12.2 m	Insert Boom

↗ mark shows the guy line installing position when the fixed jib is used.

\* Indicates the most flexible combination of insert booms, which can be modified to form all shorter boom arrangements.

# HYDRAULIC CRAWLER CRANE CKE1800

## Fixed Jib Arrangements

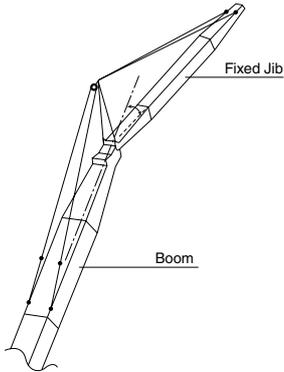

Crane boom length	Jib length m (ft)	Jib arrangement
24.4 m 73.2 m	12.2(40)	
	18.3 (60)	
	24.4 (80)	
	30.5 (100)	

Symbol	Jib Length	Remarks
	4.6 m	Jib Base
	4.6 m	Jib Top
	3.0 m	Insert Jib
	6.1 m	Insert Jib

## Long Boom Arrangements

Boom length m (ft)	Long Boom arrangement
61.0 (200)	
64.0 (210)	
67.1 (220)	
70.1 (230)	
73.2 (240)	
76.2 (250)	
79.3 (260)	
82.3 (270)	
85.3 (280)	

Symbol	Long Boom Length	Remarks
	8.5 m	Boom Base
	6.4 m	Luffing Jib Top
	3.0 m	Insert Boom
	6.1 m	Insert Boom
	9.1 m	Insert Boom
	3.6 m	Tapered Boom
	3.0 m	Luffing Insert Jib
	6.1 m	Luffing Insert Jib
	9.1 m	Luffing Insert Jib

※ Indicates the most flexible combination of insert long booms, which can be modified to form all shorter long boom arrangements.

## Luffing Boom Arrangements for Luffing

Boom length m (ft)	Boom arrangement
21.3 (70)	
24.4 (80)	
27.4 (90)	
30.5 (100)	
33.5 (110)	
36.6 (120)	

Boom length m (ft)	Boom arrangement
39.6 (130)	
42.7 (140)	
45.7 (150)	
48.8 (160)	
51.8 (170)	
54.9 (180)	

Symbol	Luffing Boom Length	Remarks
	8.5 m	Boom Base
	3.7 m	Luffing Boom Top
	3.0 m	Insert Boom
	6.1 m	Insert Boom
	9.1 m	Insert Boom

※ Indicates the most flexible combination of insert luffing booms, which can be modified to form all shorter luffing boom arrangements.

## Luffing Boom Arrangements for Crane

Boom length m (ft)	Boom arrangement
15.2 (50)	
18.3 (60)	
21.3 (70)	
24.4 (80)	
27.4 (90)	
30.5 (100)	
33.5 (110)	

Boom length m (ft)	Boom arrangement
36.6 (120)	
39.6 (130)	
42.7 (140)	
45.7 (150)	
48.8 (160)	
51.8 (170)	
54.9 (180)	

Symbol	Luffing Boom Length	Remarks
	8.5 m	Boom Base
	3.7 m	Luffing Boom Top
	3.0 m	Insert Boom
	6.1 m	Insert Boom
	9.1 m	Insert Boom

※ Indicates the most flexible combination of insert luffing booms, which can be modified to form all shorter luffing boom arrangements.

# HYDRAULIC CRAWLER CRANE CKE1800

## Luffing Jib Arrangements

Jib length m (ft)	Jib arrangement
21.3 (70)	
24.4 (80)	
27.4 (90)	
30.5 (100)	
33.5 (110)	

Jib length m (ft)	Jib arrangement
36.6 (120)	
39.6 (130)	
42.7 (140)	
45.7 (150)	
48.8 (160)	
51.8 (170)	

Symbol	Luffing Jib Length	Remarks
	5.8 m	Luffing Jib Base
	6.4 m	Luffing Jib Top
	3.0 m	Luffing Insert Jib
	6.1 m	Luffing Insert Jib
	9.1 m	Luffing Insert Jib

※ Indicates the most flexible combination of insert luffing jibs, which can be modified to form all shorter luffing jib arrangements.

## Luffing Boom and Jib Combinations.

		Jib Length (m)										
		21.3	24.4	27.4	30.5	33.5	36.6	39.6	42.7	45.7	48.8	51.8
Boom Length (m)	21.3	○	○	○	○	○	○	○	○	○	○	○
	24.4	○	○	○	○	○	○	○	○	○	○	○
	27.4	○	○	○	○	○	○	○	○	○	○	○
	30.5	○	○	○	○	○	○	○	○	○	○	○
	33.5	○	○	○	○	○	○	○	○	○	○	○
	36.6	○	○	○	○	○	○	○	○	○	○	○
	39.6	○	○	○	○	○	○	○	○	○	○	○
	42.7	○	○	○	○	○	○	○	○	○	○	○
	45.7	○	○	○	○	○	○	○	○	○	○	○
	48.8	○	○	○	○	○	○	○	○	○	○	○
	51.8	○	○	○	○	○	○	○	○	○	○	○
54.9	○	○	○	○	○	○	○	○	○	○	○	

○ : Combinations which is allowed



### Hook Blocks

A range of hook blocks can be specified, each with a safety latch.

Hooks	Weight (kg)	No. of sheaves	No. of lines and max. rated loads (tons)					
			1	2	3	4	5	6
180/160-ton	2,800	8	-	26.8	40.1	53.5	66.9	80.3
110-ton	1,800	4	-	26.8	40.1	53.5	66.9	80.3
70-ton	1,200	3	-	26.8	40.1	53.5	66.9	70.0
35-ton	900	1	-	26.8	35.0	-	-	-
13.5-ton ball hook	460	0	13.5	-	-	-	-	-

Hooks	Weight (kg)	No. of sheaves	No. of lines and max. rated loads (tons)					
			7	8	9	10	12	14
180/160-ton	2,800	8	93.7	107.0	120.4	133.8	160.0	180.0
110-ton	1,800	4	93.7	107.0	110.0	-	-	-
70-ton	1,200	3	-	-	-	-	-	-
35-ton	900	1	-	-	-	-	-	-
13.5-ton ball hook	460	0	-	-	-	-	-	-



### Main Hoist Drum Rated Loads in Metric Tons

No. of Parts of Line	1	2	3	4	5	6
Max. Loads (ton)	13.5	26.8	40.1	53.5	66.9	80.3
No. of Parts of Line	7	8	9	10	12	14
Max. Loads (ton)	93.7	107.0	120.4	133.8	160.0	180.0

### Symbols for Attachments:

								
Crane Boom	Auxiliary Sheave for Crane Boom	Luffing Boom	Aux. Sheave for Luffing Boom	Long Boom	Aux. Sheave for Long Boom	Fixed Jib	Luffing Jib	Luffing Boom with Luffing Jib

# WORKING RANGES AND LIFTING CAPACITIES

## Crane Boom Working Ranges

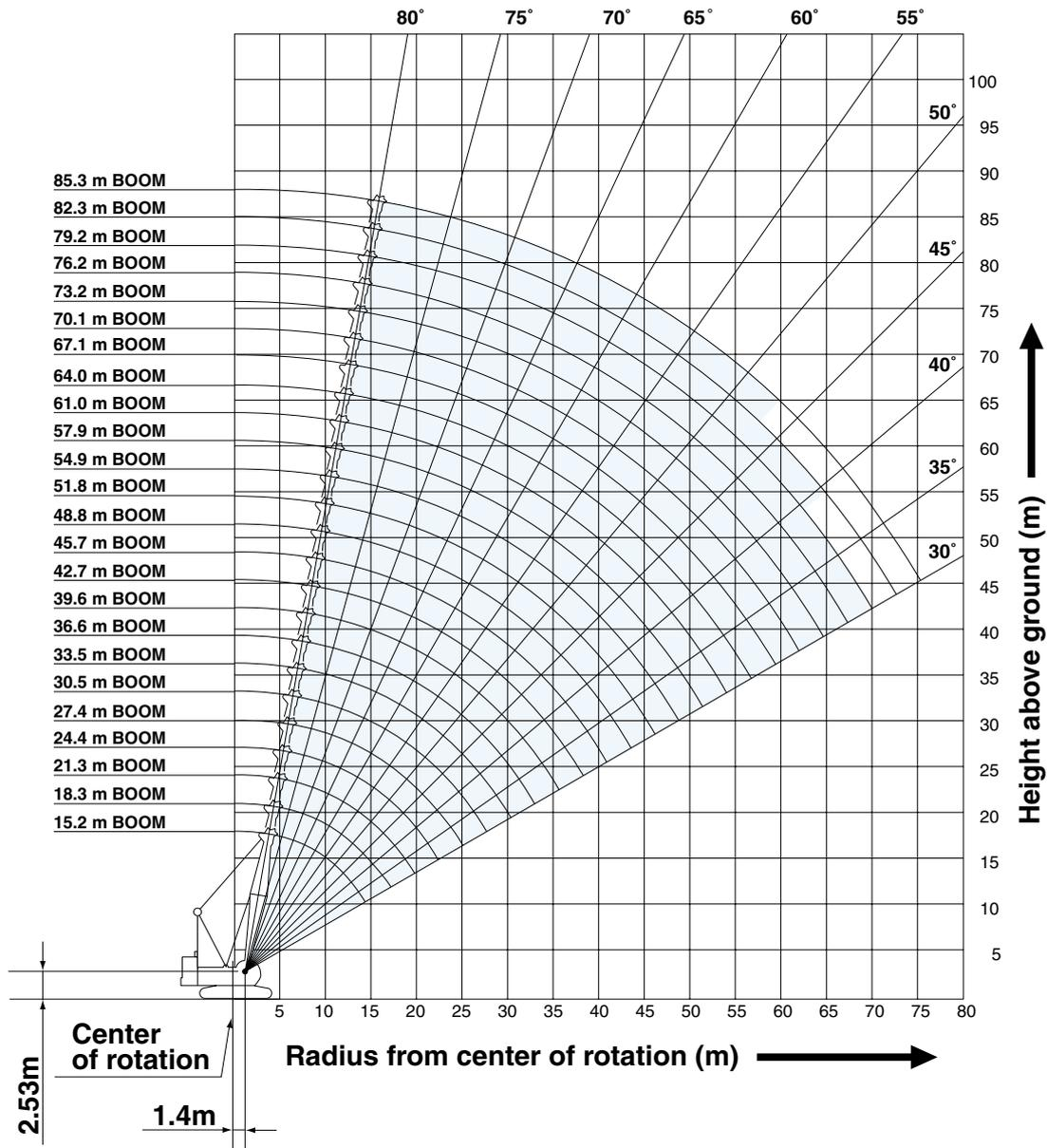

### NOTES:

1. Ratings according to EN13000.
2. Ratings in metric tons for 360° working area.
3. Operating radius is the horizontal distance from center of rotation to a vertical line through the center of gravity of the load.
4. Deduct weight of hook block(s), slings and all other load handling accessories from main boom or auxiliary sheave ratings shown.
5. Ratings shown are based on freely suspended loads and make no allowance for such factors as wind effect on lifted load, ground conditions out-of-level, operating speeds or any other condition that could be detrimental to the safe operation of this equipment. Operator, therefore, has the responsibility to judge the existing conditions and reduce lifted loads and operating speeds accordingly.
6. Ratings are for operation on a firm and level surface, up to 1% gradient.
7. At radii and boom lengths where no ratings are shown on chart, operation is not intended nor approved.
8. Boom inserts and guy lines must be arranged as shown in the "Operator's Manual".
9. Boom hoist reeving is 16 part line.
10. Gantry must be in raised position for all conditions.
11. Boom backstops are required for all boom lengths.
12. The boom should be erected over the front of crawlers, not laterally.
13. Ratings shown in   are determined by the strength of the boom or other structural component.
14. Instruction in the "Operator's Manual" must be strictly observed when operating the machine.
15. Crane boom ratings: Deduct weight of hook block(s), slings, and all other load handling accessories from crane boom ratings shown.
16. Auxiliary sheave ratings: Deduct 0.6 ton (weight of auxiliary sheave frame), weight of hook block(s), slings and all other load handling accessories from crane boom ratings shown, but should not exceed 26.8 tons.  
Crane boom lengths for auxiliary sheave mounting are 15.2 m to 82.3 m.
17. Crane boom ratings with auxiliary sheave: Deduct 0.6 ton, weight of hook block(s), slings and all other load handling accessories from crane boom ratings shown. Minimum ratings is 1.6 tons.
18. Heavy duty crane boom ratings: Deduct weight of hook block(s), slings and all other load handling accessories from crane boom ratings shown.



# Crane Boom Lifting Capacity

Unit: metric ton

Counterweight: 60.0 t, Carbody weight: 20.0 t

Working radius (m)	Boom Length (m)														Working radius (m)	
	12.2*	15.2	18.3	21.3	24.4	27.4	30.5	33.5	36.6	39.6	42.7	45.7	48.8	51.8		
3.0	3.75m/180.0															3.0
4.0	171.5	4.4m/160.0	4.9m/144.2													4.0
5.0	140.5	141.6	141.6	5.4m/131.4	5.9m/121.3											5.0
6.0	119.1	119.3	119.3	119.3	119.3	6.4m/112.0	6.9m/103.9									6.0
7.0	102.0	102.7	102.7	102.7	102.7	102.7	102.5	7.4m/97.1	7.9m/90.6							7.0
8.0	88.1	89.5	89.5	89.5	89.5	89.5	89.5	89.5	89.5	8.4m/80.3	8.9m/76.8					8.0
9.0	76.8	79.0	79.0	79.0	79.0	79.0	79.0	79.0	79.0	79.0	78.4	76.3	9.4m/70.6			9.0
10.0	67.7	71.5	71.5	71.5	71.5	71.5	71.5	71.5	71.5	71.5	70.2	68.4	66.6	10.0m/65.4	10.5m/60.7	10.0
12.0	51.4	58.8	58.7	58.6	58.5	58.4	58.3	58.2	58.2	57.8	56.5	55.1	54.0	52.8		12.0
14.0	12.4m/50.0	47.2	47.7	47.6	47.4	47.3	47.2	47.0	47.0	46.9	46.7	46.5	46.0	45.0		14.0
16.0		14.8m/41.9	40.2	40.1	39.9	39.8	39.6	39.4	39.4	39.3	39.1	38.9	38.8	38.6		16.0
18.0			17.5m/35.9	34.4	34.2	34.1	34.0	33.7	33.7	33.6	33.3	33.2	33.1	32.9		18.0
20.0				30.1	29.8	29.6	29.5	29.3	29.2	29.1	28.9	28.7	28.6	28.4		20.0
22.0				20.1m/29.9	26.5	26.3	26.2	25.9	25.8	25.7	25.5	25.3	25.3	25.0		22.0
24.0					22.7m/25.4	23.6	23.4	23.2	23.0	22.9	22.7	22.5	22.4	22.2		24.0
26.0						25.4m/22.0	21.1	20.9	20.7	20.6	20.4	20.2	20.1	19.9		26.0
28.0							28.0m/19.2	19.0	18.8	18.7	18.5	18.3	18.2	18.0		28.0
30.0								17.4	17.2	17.1	16.9	16.7	16.6	16.4		30.0
32.0								30.7m/16.9	15.8	15.7	15.4	15.2	15.1	14.9		32.0
34.0									33.3m/15.0	14.4	14.2	14.0	13.9	13.6		34.0
36.0										35.9m/13.4	13.1	13.0	12.8	12.6		36.0
38.0											12.2	12.1	11.8	11.7		38.0
40.0											38.6m/12.0	11.1	11.0	10.7		40.0
42.0												41.2m/10.7	10.3	10.0		42.0
44.0													43.8m/9.7	9.4		44.0
46.0														8.7		46.0
48.0														46.5m/8.6		48.0
Reeves	14	12	12	10	10	9	8	8	7	6	6	6	5	5	Reeves	

\* Values of 12.2 m boom length are lifting capacities for heavy duty crane boom.

Working radius (m)	Boom Length (m)														Working radius (m)
	54.9	57.9	61.0	64.0	67.1	70.1	73.2	76.2	79.2	82.3	85.3				
10.0	11.0m/56.4	11.5m/52.4													10.0
12.0	51.5	50.5	12.0m/48.3	12.5m/44.7	13.0m/41.2	13.5m/38.0									12.0
14.0	43.9	43.2	42.3	41.5	40.1	37.5	14.0m/34.5	14.5m/31.8	15.0m/29.0	15.5m/25.9					14.0
16.0	38.1	37.5	36.7	36.1	35.3	34.8	32.2	30.1	27.9	25.3	16.1m/21.0				16.0
18.0	32.7	32.7	32.3	31.8	31.1	30.7	29.8	27.8	25.9	22.9	19.0				18.0
20.0	28.3	28.2	28.0	27.9	27.7	27.3	26.7	25.8	23.9	20.9	17.2				20.0
22.0	24.9	24.8	24.6	24.5	24.4	24.2	24.0	23.6	22.0	19.1	15.6				22.0
24.0	22.1	22.0	21.9	21.7	21.6	21.4	21.4	21.3	20.3	17.5	14.2				24.0
26.0	19.7	19.7	19.4	19.4	19.2	19.0	19.0	18.9	18.7	16.0	13.0				26.0
28.0	17.8	17.7	17.5	17.5	17.3	17.1	17.0	17.0	16.8	14.7	11.8				28.0
30.0	16.2	16.1	15.9	15.8	15.6	15.5	15.4	15.3	15.2	13.5	10.8				30.0
32.0	14.7	14.6	14.4	14.3	14.2	14.0	13.9	13.8	13.7	12.4	9.9				32.0
34.0	13.5	13.4	13.2	13.1	12.9	12.8	12.7	12.6	12.4	11.4	9.0				34.0
36.0	12.4	12.3	12.1	12.0	11.9	11.7	11.6	11.5	11.3	10.4	8.2				36.0
38.0	11.4	11.3	11.2	11.1	10.9	10.8	10.7	10.5	10.3	9.6	7.4				38.0
40.0	10.6	10.4	10.2	10.2	10.0	9.8	9.7	9.6	9.4	8.7	6.7				40.0
42.0	9.9	9.7	9.5	9.4	9.3	9.1	9.0	8.9	8.7	8.0	6.0				42.0
44.0	9.2	9.0	8.9	8.8	8.5	8.4	8.3	8.2	8.0	7.3	5.4				44.0
46.0	8.5	8.4	8.2	8.1	7.9	7.7	7.6	7.5	7.4	6.6	4.8				46.0
48.0	8.0	7.9	7.6	7.6	7.4	7.2	7.1	7.0	6.8	6.0	4.2				48.0
50.0	49.1m/7.7	7.4	7.1	7.0	6.9	6.7	6.6	6.5	6.3	5.4	3.7				50.0
52.0		51.8m/6.9	6.7	6.6	6.4	6.2	6.0	5.9	5.8	4.8	3.2				52.0
54.0			6.2	6.2	6.0	5.7	5.6	5.5	5.3	4.3	2.7				54.0
56.0			54.4m/6.1	5.8	5.5	5.3	5.2	5.0	4.8	3.8	2.2				56.0
58.0				57.0m/5.5	5.1	4.9	4.7	4.6	4.4	3.3	1.8				58.0
60.0					59.7m/4.8	4.5	4.4	4.2	4.0	2.8	59.0m/1.6				60.0
62.0						4.2	4.0	3.9	3.7	2.4					62.0
64.0						62.3m/4.1	3.7	3.6	3.3	1.9					64.0
66.0							65.0m/3.5	3.2	2.9	65.0m/1.7					66.0
68.0								67.6m/3.0	2.4						68.0
70.0									70.0m/2.0						70.0
reeves	5	4	4	4	4	3	3	3	3	2	2				reeves

Note: Ratings according to EN13000.

Ratings shown in   are determined by the strength of the boom or other structural components.

Refer to notes P12.

## Luffing Boom Working Ranges

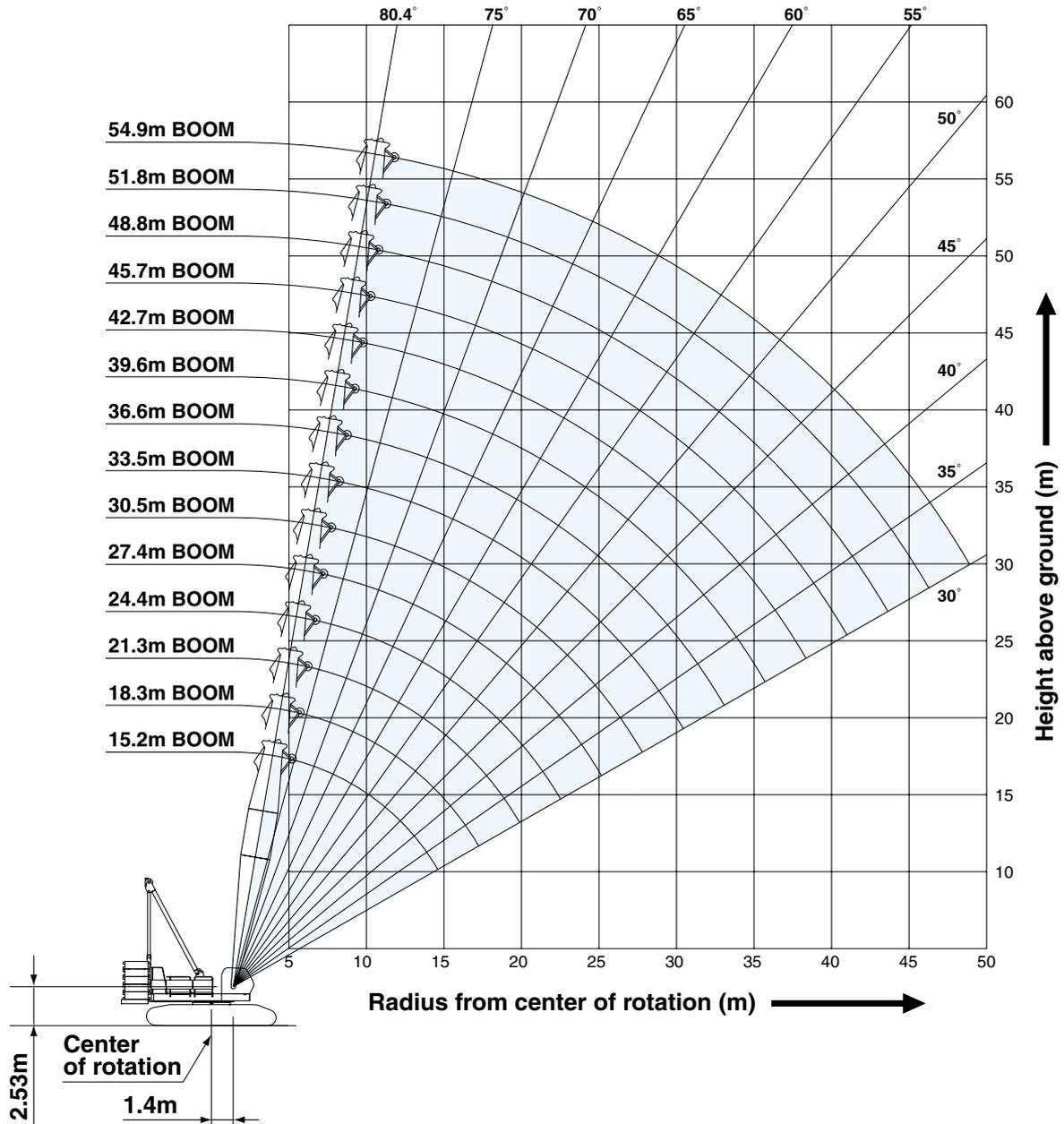

### NOTES:

1. Ratings according to EN13000.
2. Ratings in metric tons for 360° working area.
3. Operating radius is the horizontal distance from center of rotation to a vertical line through the center of gravity of the load.
4. Deduct weight of hook block(s), slings and all other load handling accessories from long boom or jib ratings shown.
5. Ratings shown are based on freely suspended loads and make no allowance for such factors as wind effect on lifted load, ground conditions out-of-level, operating speeds or any other condition that could be detrimental to the safe operation of this equipment. Operator, therefore, has the responsibility to judge the existing conditions and reduce lifted loads and operating speeds accordingly.
6. Ratings are for operation on a firm and level surface, up to 1% gradient.
7. At radii and boom lengths where no ratings are shown on chart, operation is not intended nor approved.
8. Boom/ jib inserts and guy lines must be arranged as shown in the "Operator's Manual".
9. Boom hoist reeving is 16 part line.
10. Gantry must be in raised position for all conditions.
11. Boom backstops are required for all boom lengths.
12. The boom should be erected over the front of crawlers, not laterally.
13. Ratings shown in   are determined by the strength of the boom or other structural component.
14. Instruction in the "Operator's Manual" must be strictly observed when operating the machine.
15. Luffing boom ratings: Deduct weight of hook block(s), slings and all other load handling accessories from luffing boom ratings shown.
16. Auxiliary sheave ratings: Deduct 0.6 ton (weight of auxiliary sheave frame), weight of hook block(s), slings and all other load handling accessories from luffing boom ratings shown, but should not exceed 26.8 tons.  
Luffing boom lengths for auxiliary sheave mounting are 15.2 m to 54.9 m.
17. Luffing boom ratings with auxiliary sheave: Deduct 0.6 ton, weight of hook block(s), slings and all other load handling accessories from luffing boom ratings shown.



# Luffing Boom Lifting Capacity

Unit: metric ton

Counterweight: 60.0 t, Carbody weight: 20.0 t

Working radius (m) \ Boom Length (m)	15.2	18.3	21.3	24.4	27.4	30.5	33.5	36.6	39.6	42.7	45.7	48.8	51.8	54.9	Working radius (m) \ Boom Length (m)
5.0	5.2m/110.0	5.7m/107.0													5.0
6.0	107.0	106.7	6.2m/106.2	6.8m/103.7											6.0
7.0	101.3	101.2	101.1	101.0	7.3m/96.8	7.8m/90.4									7.0
8.0	89.8	89.7	89.6	89.5	89.4	89.3	8.3m/85.5	8.8m/80.3							8.0
9.0	79.4	79.3	79.3	79.1	79.0	79.0	78.8	78.7	9.3m/75.5	9.8m/69.3					9.0
10.0	71.2	71.1	71.0	70.9	70.8	70.7	70.6	70.5	69.4	67.5	10.3m/64.0	10.8m/59.3	11.3m/55.1	11.8m/51.3	10.0
12.0	57.5	57.3	57.2	57.0	56.9	56.8	56.6	56.6	56.5	55.5	54.2	52.9	51.6	50.4	12.0
14.0	46.2	46.4	46.3	46.1	46.0	45.9	45.7	45.7	45.6	45.4	45.2	44.8	43.7	42.7	14.0
16.0	15.2m/39.2	39.0	38.9	38.6	38.5	38.4	38.2	38.1	38.0	37.8	37.7	37.6	37.4	36.9	16.0
18.0		17.8m/33.6	33.2	32.9	32.8	32.7	32.5	32.4	32.3	32.1	32.0	31.9	31.7	31.5	18.0
20.0			29.2	28.7	28.6	28.4	28.2	28.1	28.0	27.8	27.7	27.6	27.4	27.2	20.0
22.0			20.5m/28.0	25.3	25.2	25.1	24.8	24.7	24.6	24.4	24.2	24.2	24.0	23.8	22.0
24.0				23.1m/23.7	22.5	22.3	22.1	22.0	21.9	21.6	21.5	21.4	21.2	21.0	24.0
26.0					25.7m/20.4	20.1	19.8	19.7	19.6	19.3	19.2	19.1	18.9	18.7	26.0
28.0						18.2	17.9	17.8	17.7	17.5	17.3	17.2	17.0	16.8	28.0
30.0						28.4m/17.8	16.3	16.2	16.1	15.8	15.7	15.6	15.4	15.2	30.0
32.0							31.0m/15.6	14.8	14.7	14.4	14.3	14.2	13.9	13.8	32.0
34.0								33.7m/13.8	13.5	13.3	13.1	13.0	12.7	12.6	34.0
36.0									12.5	12.2	12.0	11.9	11.7	11.5	36.0
38.0									36.3m/12.3	11.2	11.0	10.9	10.7	10.5	38.0
40.0										38.9m/10.9	10.3	10.2	9.9	9.7	40.0
42.0											41.6m/9.7	9.4	9.1	9.0	42.0
44.0												8.8	8.5	8.3	44.0
46.0												44.2m/8.6	7.8	7.7	46.0
48.0													46.9m/7.6	7.1	48.0
50.0														49.5m/6.7	50.0
Reeves	8	8	8	8	8	7	7	6	6	6	5	5	5	4	Reeves

Note: Ratings according to EN13000.

Ratings shown in   are determined by the strength of the boom or other structural components.

Refer to notes P14.

## Long Boom Working Ranges

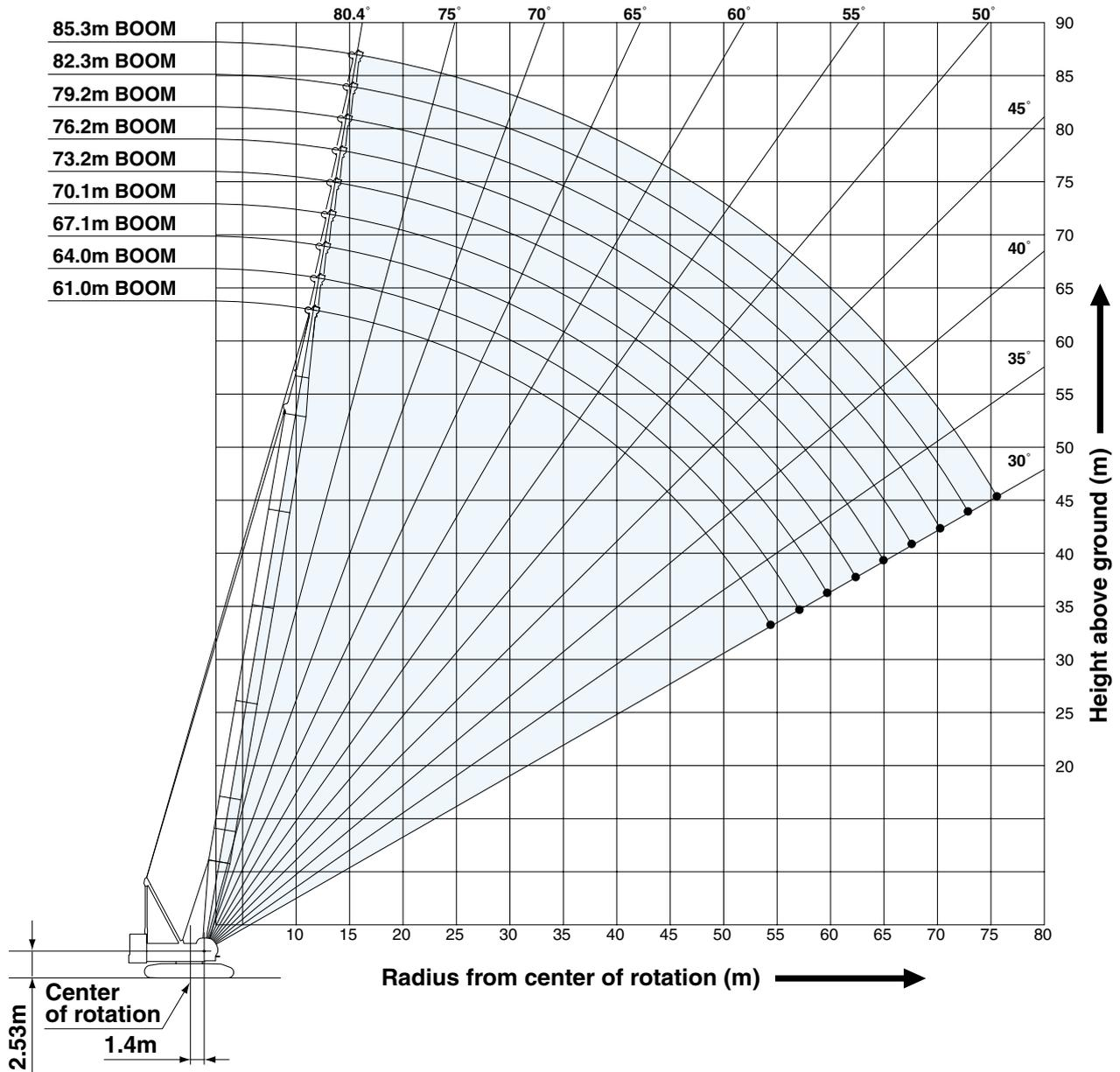

### NOTES:

1. Ratings according to EN13000.
2. Ratings in metric tons for 360° working area.
3. Operating radius is the horizontal distance from center of rotation to a vertical line through the center of gravity of the load.
4. Deduct weight of hook block(s), slings and all other load handling accessories from long boom or jib ratings shown.
5. Ratings shown are based on freely suspended loads and make no allowance for such factors as wind effect on lifted load, ground conditions out-of-level, operating speeds or any other condition that could be detrimental to the safe operation of this equipment. Operator, therefore, has the responsibility to judge the existing conditions and reduce lifted loads and operating speeds accordingly.
6. Ratings are for operation on a firm and level surface, up to 1% gradient.
7. At radii and boom lengths where no ratings are shown on chart, operation is not intended nor approved.
8. Boom/ jib inserts and guy lines must be arranged as shown in the "Operator's Manual".
9. Boom hoist reeving is 16 part line.
10. Gantry must be in raised position for all conditions.
11. Boom backstops are required for all boom lengths.
12. Ratings shown in   are determined by the strength of the boom or other structural component.
13. Instruction in the "Operator's Manual" must be strictly observed when operating the machine.
14. Long boom ratings: Deduct weight of hook block(s), slings and all other load handling accessories from long boom ratings shown.
15. Auxiliary sheave ratings: Deduct 0.4 ton (weight of auxiliary sheave frame), weight of hook block(s), slings and all other load handling accessories from long boom ratings shown, but should not exceed 13.5 tons. Long boom length for auxiliary sheave mounting are 61.0 m to 79.2 m.



# Long Boom Lifting Capacity

Unit: metric ton

Counterweight: 60.0 t,  
Carbody weight: 20.0 t

Working radius (m)	Boom Length (m)									Boom Length (m)		Working radius (m)
	61.0	64.0	67.1	70.1	73.2	76.2	79.2	82.3	85.3			
10.0	11.9m/40.1										10.0	
12.0	40.1	12.4m/37.8	12.9m/35.0	13.4m/33.2	13.9m/31.6						12.0	
14.0	37.2	35.8	34.5	32.8	31.5	14.4m/27.9	14.9m/23.9	15.5m/20.7			14.0	
16.0	34.1	33.1	32.1	30.6	29.5	26.5	23.2	20.4	20.3		16.0	
18.0	31.0	30.3	29.6	28.4	27.5	24.9	21.9	19.4	19.3		18.0	
20.0	27.9	27.4	27.1	26.2	25.5	23.3	20.6	18.4	18.3		20.0	
22.0	24.9	24.7	24.5	24.0	23.5	21.7	19.5	17.4	17.3		22.0	
24.0	22.1	22.0	21.9	21.8	21.5	20.1	18.3	16.4	16.4		24.0	
26.0	19.8	19.7	19.6	19.6	19.5	18.5	17.1	15.5	15.5		26.0	
28.0	17.9	17.8	17.7	17.6	17.5	17.0	16.0	14.7	14.7		28.0	
30.0	16.3	16.2	16.1	16.0	15.9	15.5	14.9	13.9	13.9		30.0	
32.0	14.9	14.8	14.6	14.6	14.5	14.1	13.7	13.0	13.0		32.0	
34.0	13.6	13.5	13.4	13.4	13.2	12.9	12.8	12.3	12.3		34.0	
36.0	12.6	12.5	12.3	12.3	12.2	11.9	11.8	11.5	11.5		36.0	
38.0	11.6	11.5	11.4	11.3	11.2	10.9	10.9	10.8	10.8		38.0	
40.0	10.8	10.7	10.5	10.5	10.4	10.1	10.0	10.0	10.0		40.0	
42.0	10.0	9.9	9.8	9.7	9.6	9.4	9.3	9.3	9.3		42.0	
44.0	9.3	9.2	9.1	9.0	8.9	8.7	8.6	8.6	8.6		44.0	
46.0	8.7	8.6	8.5	8.4	8.3	8.1	8.0	8.0	8.0		46.0	
48.0	8.2	8.0	7.9	7.9	7.7	7.5	7.4	7.4	7.4		48.0	
50.0	7.7	7.5	7.4	7.3	7.2	7.0	6.9	6.9	6.9		50.0	
52.0	7.2	7.1	6.9	6.9	6.7	6.5	6.5	6.5	6.5		52.0	
54.0	6.8	6.6	6.5	6.4	6.3	6.1	6.0	6.0	6.0		54.0	
56.0	54.5m/6.7	6.3	6.1	6.1	5.9	5.7	5.7	5.7	5.6		56.0	
58.0		57.2m/6.0	5.8	5.7	5.6	5.4	5.3	5.3	5.2		58.0	
60.0			59.8m/5.5	5.4	5.2	5.0	5.0	5.0	4.8		60.0	
62.0				5.0	4.9	4.7	4.6	4.6	4.4		62.0	
64.0				62.4m/5.0	4.6	4.4	4.4	4.3	4.1		64.0	
66.0					65.1m/4.5	4.2	4.1	4.0	3.8		66.0	
68.0						67.7m/3.9	3.8	3.7	3.5		68.0	
70.0							3.5	3.5	3.2		70.0	
72.0							70.4m/3.4	3.2	3.0		72.0	
74.0								73.0m/3.1	2.8		74.0	
76.0									75.6m/2.6		76.0	
reeves	3	3	3	3	3	3	2	2	2		reeves	

Note: Ratings according to EN13000.

Ratings shown in  are determined by the strength of the boom or other structural components.

Refer to notes P16.

# HYDRAULIC CRAWLER CRANE CKE1800

## Fixed Jib Working Ranges

Jib Offset Angle: 10°, 30°

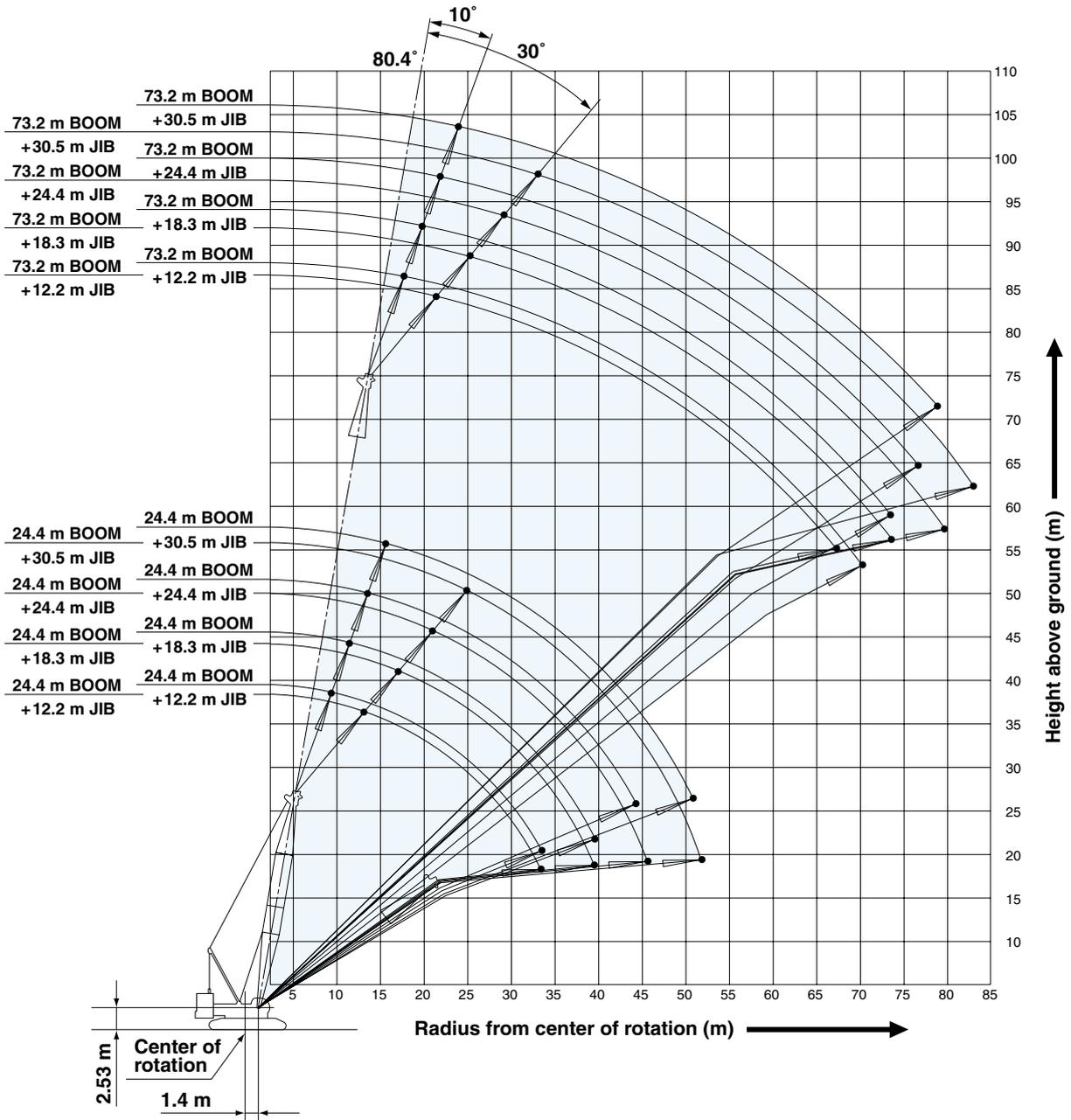

### NOTES:

1. Ratings according to EN 13000.
2. Ratings in metric tons for 360° working area.
3. Operating radius is the horizontal distance from center of rotation to a vertical line through the center of gravity of the load.
4. Deduct weight of hook block (s), slings and all other load handling accessories from fixed jib ratings shown.
5. Ratings shown are based on freely suspended loads and make no allowance for such factors as wind effect on lifted load, ground conditions out-of-level, operating speeds or any other condition that could be detrimental to the safe operation of this equipment. Operator, therefore, has the responsibility to judge the existing conditions and reduce lifted loads and operating speeds accordingly.
6. Ratings are for operation on a firm and level surface, up to 1% gradient.
7. At radii and boom lengths where no ratings are shown on chart, operation is not intended nor approved.
8. Boom inserts and guy lines must be arranged as shown in the "Operator's Manual".
9. Boom hoist reeving is 16 part line.
10. Gantry must be in raised position for all conditions.
11. Boom backstops are required for all boom lengths.
12. Ratings shown in   are determined by the strength of the boom or other structural component.
13. The boom should be erected over the front of the crawlers not laterally.
14. Instruction in the "Operator's Manual" must be strictly observed when operating the machine.
15. Fixed jib ratings: Deduct weight of hook block (s), slings, and all other load handling accessories from jib ratings shown.
16. Boom lengths for jib mounting are 24.4 m to 73.2 m.
17. One part of line on hook is not allowed to use for 12.2 m jib length with offset angle 10 degrees.



# Fixed Jib Lifting Capacities (Without Main Hook)

Unit: metric ton

Jib Offset Angle: 10°

Counterweight: 60.0 t, Carbody weight: 20.0 t

Boom length (m)		24.4				33.5				42.7				51.8				Boom length (m)
Jib length (m)		12.2	18.3	24.4	30.5	12.2	18.3	24.4	30.5	12.2	18.3	24.4	30.5	12.2	18.3	24.4	30.5	Jib length (m)
Working radius (m)	9.0	9.8m/26.8																9.0
	10.0	26.8	11.0m/19.5			11.0m/26.8												10.0
	12.0	26.5	19.3	12.8m/10.1		26.3	12.8m/19.4			12.2m/26.8								12.0
	14.0	23.1	18.9	9.9	14.0m/6.1	24.3	19.1	14.6m/10.1		26.0	14.6m/19.3				14.0m/26.8			14.0
	16.0	20.7	18.1	9.7	5.9	22.8	18.7	9.9	16.8m/6.0	24.6	19.1	16.8m/10.0		26.0	16.8m/19.2			16.0
	18.0	19.2	17.5	9.5	5.8	21.4	18.2	9.7	5.9	23.2	18.6	9.9	18.3m/6.0	24.6	18.9	18.3m/9.9	19.8m/6.0	18.0
	20.0	18.0	16.2	9.3	5.6	20.1	17.6	9.5	5.8	21.9	18.1	9.7	5.9	23.4	18.5	9.8	6.0	20.0
	22.0	16.9	14.3	8.8	5.3	19.1	16.7	9.3	5.6	20.8	17.7	9.5	5.8	22.3	18.1	9.7	5.9	22.0
	24.0	16.0	13.2	8.4	5.0	18.1	15.4	9.0	5.4	19.8	17.2	9.4	5.7	21.3	17.8	9.5	5.8	24.0
	26.0	15.2	12.2	8.1	4.8	17.1	14.3	8.7	5.2	18.9	16.1	9.2	5.5	20.0	17.4	9.4	5.6	26.0
	28.0	14.4	11.3	7.8	4.6	16.4	13.3	8.3	4.9	18.0	15.1	8.8	5.3	18.1	16.7	9.3	5.5	28.0
	30.0	13.7	10.6	7.4	4.4	15.7	12.5	8.0	4.7	16.8	14.2	8.6	5.0	16.4	15.7	9.0	5.3	30.0
	34.0	33.5m/12.7	9.4	6.9	4.0	14.5	11.1	7.5	4.4	14.2	12.6	8.0	4.7	13.7	13.9	8.5	4.9	34.0
	38.0		8.4	6.5	3.7	12.7	10.0	7.1	4.0	12.2	11.4	7.6	4.4	11.6	11.8	8.0	4.6	38.0
	42.0		39.6m/8.2	6.2	3.4	39.6m/12.0	9.1	6.7	3.8	10.5	10.4	7.2	4.1	9.9	10.2	7.6	4.4	42.0
	46.0			44.2m/6.1	3.2		45.7m/8.4	6.4	3.5	9.2	9.4	6.8	3.9	8.6	8.8	7.3	4.1	46.0
	50.0				3.0			6.1	3.3	48.8m/8.4	8.3	6.5	3.6	7.5	7.7	6.9	3.9	50.0
	54.0				50.3m/3.0			51.8m/6.1	3.2		7.3	6.3	3.4	6.5	6.8	6.7	3.7	54.0
	58.0								57.9m/3.0		54.9m/7.1	6.1	3.3	57.9m/5.8	5.9	6.2	3.5	58.0
	62.0											61.0m/6.0	3.1		61.0m/5.4	5.5	3.4	62.0
66.0												3.0			4.9	3.2	66.0	
70.0												67.1m/3.0			67.1m/4.7	3.1	70.0	
74.0																73.2m/3.0	74.0	
Reeves	2	2	1	1	2	2	1	1	2	2	1	1	2	2	1	1	Reeves	

Boom length (m)		61.0				70.1				73.2				Boom length (m)
Jib length (m)		12.2	18.3	24.4	30.5	12.2	18.3	24.4	30.5	12.2	18.3	24.4	30.5	Jib length (m)
Working radius (m)	16.0	16.8m/26.6				16.8m/21.7								16.0
	18.0	25.9	18.3m/19.1	19.8m/9.9		21.4	19.8m/19.1			18.3m/19.1	19.8m/18.7			18.0
	20.0	24.7	18.8	9.9	21.3m/6.0	21.0	19.1	21.3m/9.9		18.8	18.7	21.3m/9.9		20.0
	22.0	23.6	18.5	9.8	5.9	20.6	18.7	9.9	22.9m/5.9	18.4	18.3	9.9	22.9m/6.0	22.0
	24.0	21.8	18.1	9.7	5.9	20.2	18.4	9.8	5.9	18.0	17.9	9.8	5.9	24.0
	26.0	19.6	17.8	9.5	5.7	19.1	18.1	9.7	5.8	17.6	17.5	9.7	5.8	26.0
	28.0	17.6	17.3	9.4	5.6	17.1	17.4	9.5	5.7	16.9	16.9	9.5	5.7	28.0
	30.0	15.9	16.1	9.3	5.5	15.4	15.7	9.4	5.6	15.2	15.6	9.4	5.6	30.0
	34.0	13.2	13.4	8.8	5.2	12.7	13.0	9.2	5.4	12.5	12.8	9.2	5.4	34.0
	38.0	11.1	11.3	8.4	4.9	10.6	10.9	8.7	5.1	10.4	10.7	8.8	5.2	38.0
	42.0	9.4	9.7	8.0	4.6	8.9	9.2	8.3	4.8	8.8	9.0	8.4	4.9	42.0
	46.0	8.0	8.3	7.6	4.4	7.6	7.8	7.9	4.6	7.3	7.6	8.0	4.6	46.0
	50.0	6.9	7.2	7.3	4.1	6.5	6.7	7.1	4.3	6.3	6.5	6.8	4.4	50.0
	54.0	6.0	6.2	6.5	3.9	5.5	5.8	6.1	4.1	5.3	5.5	5.9	4.2	54.0
	58.0	5.2	5.4	5.7	3.7	4.6	4.9	5.3	3.9	4.4	4.6	5.1	4.0	58.0
	62.0	4.4	4.7	5.0	3.5	3.8	4.1	4.5	3.8	3.5	3.8	4.2	3.8	62.0
	66.0	64.0m/4.1	4.0	4.4	3.4	3.1	3.4	3.8	3.6	2.8	3.0	3.5	3.6	66.0
	70.0		3.4	3.7	3.3	2.4	2.7	3.1	3.3	2.1	2.4	2.8	2.9	70.0
	74.0		70.1m/3.4	3.1	3.2	73.2m/2.0	2.1	2.5	2.7	70.1m/2.1	73.2m/2.0	2.3	2.4	74.0
	78.0			76.2m/2.9	2.8		76.2m/1.9	2.0	2.2			76.2m/2.0	77.7m/2.0	78.0
82.0				2.3			79.2m/1.9	80.8m/1.9					82.0	
86.0				82.3m/2.3									86.0	
Reeves	2	2	1	1	2	2	1	1	2	2	1	1	Reeves	

Note: Ratings according to EN13000.

Ratings shown in   are determined by the strength of the boom or other structural components.

Refer to notes P18.

\* One part of line on hook is not allowed to use for 12.2 m jib length with offset angle 10 degrees.

# HYDRAULIC CRAWLER CRANE CKE1800

Unit: metric ton

## Jib Offset Angle: 30°

Counterweight: 60.0 t, Carbody weight: 20.0 t

Boom length (m)		24.4				33.5				42.7				51.8				Boom length (m)
Jib length (m)		12.2	18.3	24.4	30.5	12.2	18.3	24.4	30.5	12.2	18.3	24.4	30.5	12.2	18.3	24.4	30.5	Jib length (m)
Working radius (m)	12.0	13.4m/17.2																12.0
	14.0	17.2				14.6m/17.2												14.0
	16.0	16.0	16.8m/12.8			16.8				16.8m/17.1								16.0
	18.0	15.2	12.2			16.1	18.3m/12.8			16.7	19.8m/12.8			18.3m/17.1				18.0
	20.0	14.3	11.2	21.3m/7.5		15.6	12.1			16.1	12.8			16.6	21.3m/12.8			20.0
	22.0	13.5	10.5	7.4		14.8	11.4	22.9m/7.5		15.7	12.1			16.2	12.6			22.0
	24.0	12.7	9.8	7.2	24.4m/4.1	14.1	10.8	7.4	25.9m/4.1	15.2	11.4	24.4m/7.5		15.8	12.0	25.9m/7.5		24.0
	26.0	12.1	9.3	7.0	4.0	13.4	10.2	7.2	4.1	14.5	10.9	7.4	27.4m/4.1	15.3	11.5	7.5		26.0
	28.0	11.6	8.8	6.8	3.9	12.8	9.7	7.0	4.0	13.9	10.4	7.2	4.1	14.8	11.0	7.4	29.0m/4.1	28.0
	30.0	11.2	8.3	6.5	3.7	12.3	9.2	6.8	3.9	13.4	9.9	7.1	4.0	14.2	10.5	7.2	4.0	30.0
	34.0	33.5m/10.6	7.6	5.9	3.4	11.5	8.4	6.4	3.6	12.5	9.1	6.8	3.8	13.3	9.8	6.9	3.9	34.0
	38.0		7.1	5.4	3.3	36.6m/11.1	7.8	5.9	3.4	11.7	8.5	6.4	3.5	11.9	9.1	6.7	3.7	38.0
	42.0		39.6m/7.0	5.0	3.1		7.4	5.5	3.3	10.7	8.0	5.9	3.4	10.2	8.6	6.3	3.5	42.0
	46.0			45.7m/4.8	3.0		42.7m/7.3	5.2	3.1	45.7m/9.4	7.5	5.6	3.3	8.8	8.1	5.9	3.4	46.0
	50.0				2.9			48.8m/5.0	3.0		7.2	5.3	3.1	7.6	7.7	5.6	3.2	50.0
	54.0				51.8m/2.9				2.9		51.8m/7.1	5.0	3.0	51.8m/7.2	7.1	5.4	3.2	54.0
	58.0								54.9m/2.9			57.9m/4.9	2.9		57.9m/6.2	5.1	3.0	58.0
	62.0												2.9			4.9	3.0	62.0
	66.0												64.0m/2.9			64.0m/4.9	2.9	66.0
	70.0																2.9	70.0
74.0																70.1m/2.9	74.0	
Reeves	2	1	1	1	2	1	1	1	2	1	1	1	2	1	1	1	Reeves	

Boom length (m)		61.0				70.1				73.2				Boom length (m)
Jib length (m)		12.2	18.3	24.4	30.5	12.2	18.3	24.4	30.5	12.2	18.3	24.4	30.5	Jib length (m)
Working radius (m)	18.0	19.8m/17.1												18.0
	20.0	17.0				21.3m/17.1				21.3m/17.2				20.0
	22.0	16.6	22.9m/12.8			16.9				17.1				22.0
	24.0	16.2	12.5			16.6	24.4m/13.2			16.7	25.9m/12.9			24.0
	26.0	15.9	12.0	27.4m/7.5		16.2	12.8			16.4	12.9			26.0
	28.0	15.5	11.5	7.5		15.9	12.3	29.0m/7.5		16.0	12.4	29.0m/7.6		28.0
	30.0	15.0	11.0	7.3	30.5m/4.1	15.6	11.8	7.5	32.0m/4.1	15.6	12.0	7.5	32.0m/4.1	30.0
	34.0	13.6	10.3	7.1	3.9	13.2	11.1	7.2	4.0	13.1	11.2	7.3	4.0	34.0
	38.0	11.4	9.6	6.8	3.8	11.1	10.4	7.0	3.8	10.9	10.5	7.0	3.9	38.0
	42.0	9.7	9.1	6.6	3.6	9.3	9.8	6.8	3.7	9.1	9.8	6.8	3.7	42.0
	46.0	8.3	8.6	6.3	3.4	7.9	8.5	6.6	3.5	7.7	8.3	6.7	3.6	46.0
	50.0	7.1	7.6	5.9	3.4	6.7	7.3	6.4	3.4	6.5	7.1	6.5	3.4	50.0
	54.0	6.2	6.6	5.7	3.3	5.8	6.3	6.1	3.4	5.6	6.1	6.2	3.4	54.0
	58.0	57.9m/5.3	5.8	5.4	3.1	4.9	5.4	5.7	3.2	4.6	5.2	5.6	3.3	58.0
	62.0		5.0	5.2	3.0	4.0	4.6	4.9	3.1	3.7	4.4	4.8	3.2	62.0
	66.0		64.0m/4.7	4.6	3.0	3.2	3.8	4.2	3.1	2.9	3.6	4.0	3.1	66.0
	70.0			4.0	2.9	67.1m/3.0	3.1	3.5	3.0	67.1m/2.8	2.9	3.3	3.0	70.0
	74.0			70.1m/4.0	2.9		73.2m/2.6	2.9	2.9		73.2m/2.4	2.6	2.9	74.0
	78.0				76.2m/2.9			2.3	2.6			2.0	2.4	78.0
	82.0							79.2m/2.1	2.0			79.2m/1.9	1.8	82.0
84.0								83.8m/1.8				82.3m/1.8	84.0	
Reeves	2	1	1	1	2	1	1	1	2	1	1	1	Reeves	

Note: Ratings according to EN13000.

Ratings shown in   are determined by the strength of the boom or other structural components.

Refer to notes P18.

# Luffing Jib Working Ranges

Boom Angle: 88°

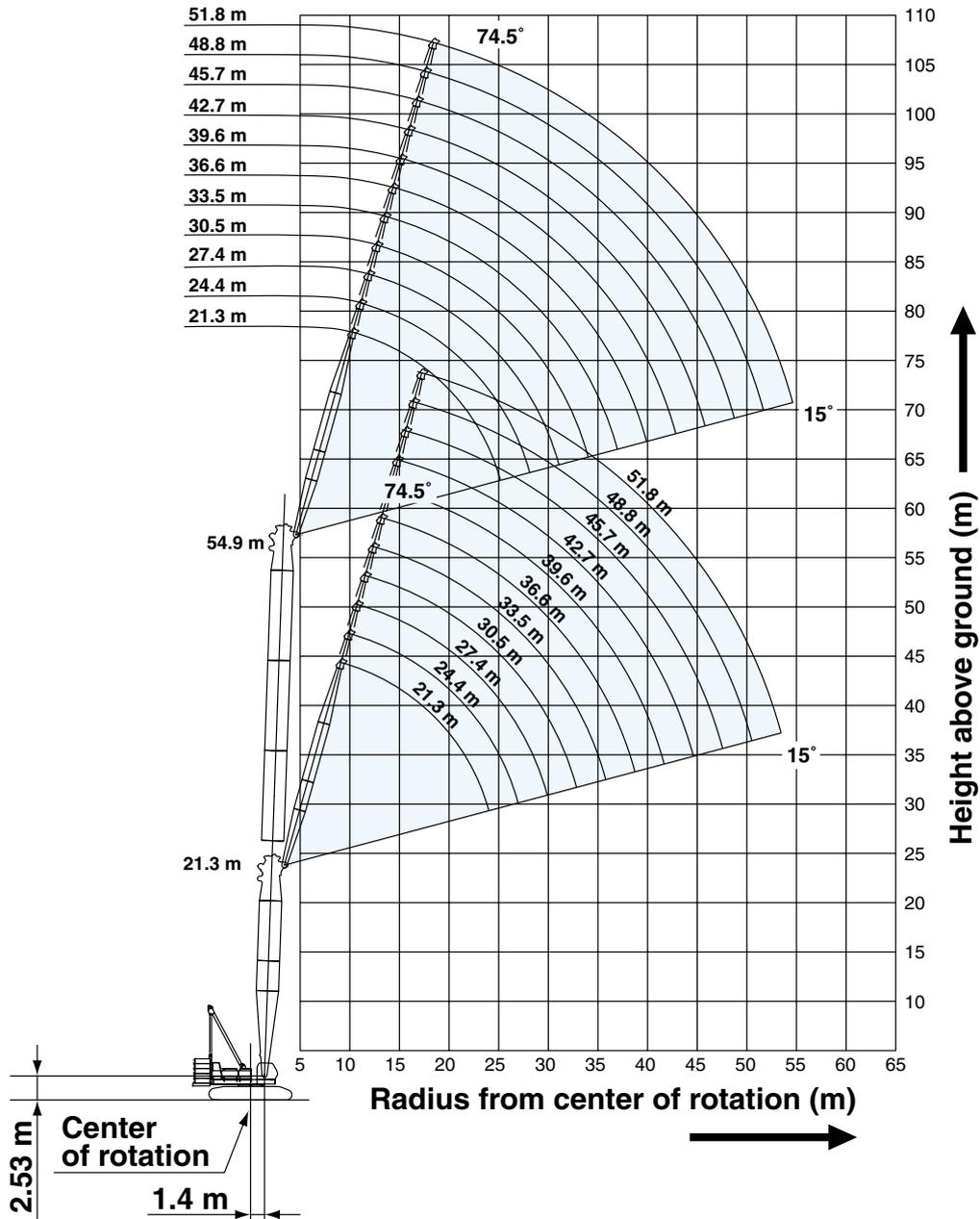

## NOTES:

1. Ratings according to EN13000.
2. Ratings in metric tons for 360° working area.
3. Operating radius is the horizontal distance from center of rotation to a vertical line through the center of gravity of the load.
4. Deduct weight of hook block(s), slings and all other load handling accessories from luffing jib ratings or main boom ratings with luffing jib shown.
5. Ratings shown are based on freely suspended loads and make no allowance for such factors as wind effect on lifted load, ground conditions out-of-level, operating speeds or any other condition that could be detrimental to the safe operation of this equipment. Operator, therefore,

6. Ratings are for operation on a firm and level surface, up to 1% gradient.
7. At radii and boom lengths where no ratings are shown on chart, operation is not intended nor approved.
8. Boom/jib inserts and guy lines must be arranged as shown in the "Operator's Manual".
9. Luffing boom hoist reeving is 16 part line.
10. Jib hoist reeving is 8 part line.

# HYDRAULIC CRAWLER CRANE CKE1800

**Boom Angle: 60°**

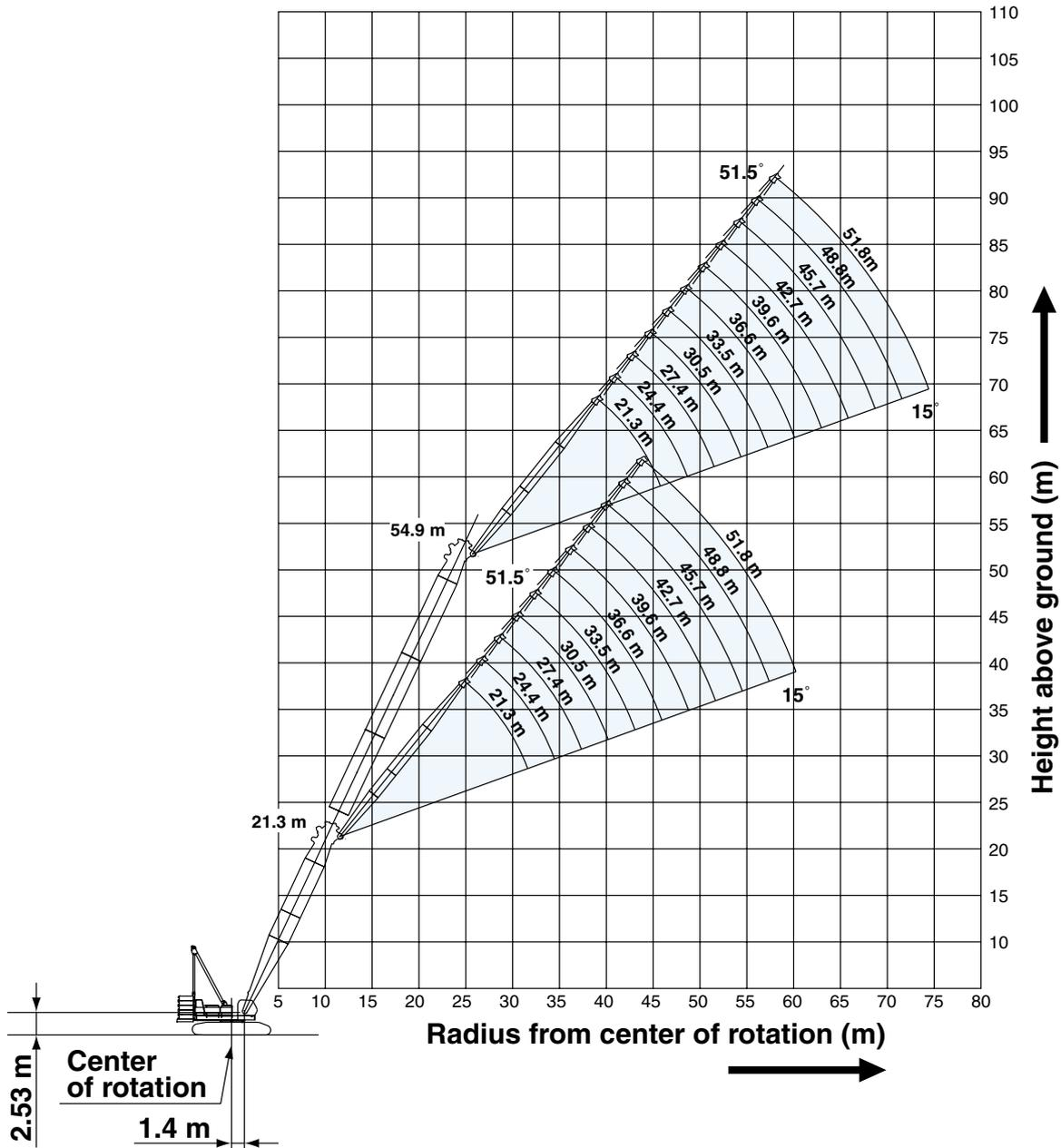

11. Gantry must be in raised position for all conditions.
12. Boom and jib backstops are required for all boom and jib combinations.
13. Ratings shown in  are determined by the strength of the boom or other structural component.
14. The boom should be erected over the front of crawlers, not laterally.
15. When erecting and lowering the all boom and jib combinations, the pillow plate for erection must be placed at the end of crawlers.
16. Instruction in the "Operator's Manual" must be strictly observed when operating the machine.
17. The minimum rated load is 2.0 tons.
18. Luffing jib ratings: Deduct weight of hook block(s), slings, and all other load handling accessories from luffing jib ratings shown.
19. Main boom ratings with luffing jib: Deduct weight of hook block(s), slings, and all other load handling accessories from main boom ratings with luffing jib shown.



# Luffing Jib Lifting Capacities (Without Main Hook)

Unit: metric ton

Counterweight: 60.0 t, Carbody weight: 20.0 t

21.3 m Boom Length	21.3																	Boom length (m)
	21.3				27.4				33.5				39.6				Jib length (m)	
	88°	83°	65°	60°	88°	83°	65°	60°	88°	83°	65°	60°	88°	83°	65°	60°	Boom angle	
Working radius (m)	9.14	48.6															9.14	
	10.0	48.3															10.0	
	12.0	47.7			47.4												12.0	
	14.0	43.3	47.4		43.2				42.9				34.6				14.0	
	16.0	35.8	40.9		35.7	40.7			35.4				33.5				16.0	
	18.0	30.4	35.1		30.2	34.9			30.0	34.7			29.7				18.0	
	20.0	26.2	30.2		26.2	30.1			25.9	30.3			25.6	30.0			20.0	
	22.0	23.0	26.1		22.9	26.0			22.7	26.1			22.4	25.9			22.0	
	24.0		22.9		20.4	22.8			20.1	22.9			19.9	22.7			24.0	
	26.0			20.3	18.2	20.3			18.0	20.3			17.7	20.1			26.0	
	28.0			18.6	16.5	18.2			16.2	18.2			16.0	17.9			28.0	
	30.0			17.1	16.7		16.4	16.7	14.7	16.4			14.5	16.2			30.0	
	34.0				32.0m/15.4			14.3	13.8	32.0m/13.4	13.6	13.9		12.1	13.4		34.0	
	38.0							36.0m/13.3	12.1		36.0m/12.5	12.2	11.7	10.3	11.2	11.8	38.0	
	42.0											10.7	10.5		9.6	10.5	42.0	
	46.0													44.0m/9.8		9.3	46.0	
	50.0														48.0m/8.8	8.1	50.0	
Reeves			4				4			4				3			Reeves	

21.3 m Boom Length	21.3								Boom length (m)
	45.7				51.8				Jib length (m)
	88°	83°	65°	60°	88°	83°	65°	60°	Boom angle
Working radius (m)	18.0	22.9							18.0
	20.0	21.2			16.3				20.0
	22.0	19.8	21.5		15.1				22.0
	24.0	18.4	19.7		14.1				24.0
	26.0	17.3	18.4		13.0	14.0			26.0
	28.0	15.9	17.3		12.3	13.1			28.0
	30.0	14.4	16.2		11.5	12.3			30.0
	34.0	12.0	13.3		10.2	10.8			34.0
	38.0	10.1	11.2		9.1	9.6			38.0
	42.0	8.6	9.5	10.0	8.2	8.6			42.0
	46.0	44.0m/8.0	8.2	9.1	8.5	7.3	7.7	8.7	46.0
	50.0		48.0m/7.6	8.1	7.8	6.3	6.8	7.8	50.0
	54.0			7.2	7.0	52.0m/6.3	6.9	6.6	54.0
	58.0				56.0m/6.6		58.0m/6.2	6.0	58.0
	62.0							5.4	62.0
Reeves			2			2			Reeves

Note: Ratings according to EN13000.  
Ratings shown in [ ] are determined by the strength of the boom or other structural components. Refer to notes P21 and P22.

# HYDRAULIC CRAWLER CRANE CKE1800

Unit: metric ton

**Counterweight: 60.0 t, Carbody weight: 20.0 t**

27.4 m Boom Length	Boom length (m)		27.4																Boom length (m)	
	Jib length (m)		21.3				27.4				33.5				39.6				Jib length (m)	
	Boom angle		88°	83°	65°	60°	88°	83°	65°	60°	88°	83°	65°	60°	88°	83°	65°	60°	Boom angle	
Working radius (m)	10.0	47.4																		10.0
	12.0	47.4				47.4														12.0
	14.0	44.6	47.4			44.5				44.2				34.6						14.0
	16.0	36.7	40.6			36.6				36.4				33.7						16.0
	18.0	31.0	34.8			30.9	34.6			30.7				30.5						18.0
	20.0	26.7	30.4			26.7	30.2			26.5	30.0			26.2	29.7					20.0
	22.0	23.4	26.9			23.4	26.7			23.1	26.6			22.9	26.4					22.0
	24.0		24.1			20.7	23.9			20.5	23.8			20.2	23.6					24.0
	26.0		21.2			18.5	21.3			18.3	21.4			18.0	21.1					26.0
	28.0					16.7	19.0			16.5	19.1			16.2	18.8					28.0
	30.0			16.4			17.1			14.9	17.1			14.7	16.9					30.0
	34.0			32.0m/15.1	13.5			13.7		32.0m/13.6	14.1	36.0m/12.2		12.2	13.9					34.0
	38.0				36.0m/12.6			11.9	11.5		36.0m/12.9	11.7	40.0m/10.2	10.3	11.7	40.0m/10.4				38.0
	42.0								40.0m/10.8			10.2	9.8		9.9	10.0				42.0
	46.0											44.0m/9.6	8.7			8.8	8.5			46.0
	50.0															7.9	7.5			50.0
54.0																52.0m/7.1			54.0	
Reeves			4			4			4			3							Reeves	

27.4 m Boom Length	Boom length (m)		27.4								Boom length (m)	
	Jib length (m)		45.7				51.8				Jib length (m)	
	Boom angle		88°	83°	65°	60°	88°	83°	65°	60°	Boom angle	
Working radius (m)	18.0	23.0									18.0	
	20.0	21.4				16.5					20.0	
	22.0	19.9				15.2					22.0	
	24.0	18.5	20.2			14.1					24.0	
	26.0	17.4	18.9			13.2	14.3				26.0	
	28.0	16.2	17.7			12.3	13.4				28.0	
	30.0	14.6	16.6			11.5	12.5				30.0	
	34.0	12.1	13.9			10.2	11.0				34.0	
	38.0	10.2	11.6			9.1	9.8				38.0	
	42.0	8.7	9.9	44.0m/8.8		8.2	8.8				42.0	
	46.0	44.0m/8.1	8.4	8.6		7.4	7.8	48.0m/7.6			46.0	
	50.0		48.0m/7.8	7.6	7.2	4.5	6.9	7.3			50.0	
	54.0			6.8	6.5		4.4	6.5	6.2		54.0	
	58.0			56.0m/6.4	5.8			5.8	5.5		58.0	
	62.0							5.2	4.9		62.0	
	66.0								64.0m/4.6		66.0	
Reeves			2			2				Reeves		

Note: Ratings according to EN13000.  
Ratings shown in   are determined by the strength of the boom or other structural components. Refer to notes P21 and P22.

Unit: metric ton

Counterweight: 60.0 t, Carbody weight: 20.0 t

33.5 m Boom Length	33.5																	
	Boom length (m)	33.5												Boom length (m)				
	Jib length (m)	21.3				27.4				33.5				39.6				Jib length (m)
Boom angle	88°	83°	65°	60°	88°	83°	65°	60°	88°	83°	65°	60°	88°	83°	65°	60°	Boom angle	
Working radius (m)	10.0	47.4															10.0	
	12.0	47.4			47.4												12.0	
	14.0	45.7	47.4		45.6				42.6								14.0	
	16.0	37.5	40.2		37.5				37.2				33.0				16.0	
	18.0	31.6	34.4		31.6	34.2			31.4				31.3				18.0	
	20.0	27.2	30.1		27.2	30.0			26.9	29.6			27.2				20.0	
	22.0	23.7	26.6		23.7	26.5			23.5	26.3			23.7	25.9			22.0	
	24.0		23.9		21.0	23.8			20.8	23.5			20.9	23.4			24.0	
	26.0		21.5		18.7	21.5			18.5	21.2			18.6	21.1			26.0	
	28.0				16.8	19.5			16.7	19.3			16.7	19.2			28.0	
	30.0			32.0m/14.4		17.9			15.1	17.7			15.1	17.6			30.0	
	34.0			13.3	36.0m/11.9			36.0m/12.2	32.0m/13.7	14.6			12.6	14.4			34.0	
	38.0				11.1			11.3	40.0m/9.8		36.0m/13.3	10.7		10.6	12.1		38.0	
	42.0							40.0m/10.6	9.5			9.7	44.0m/8.3		10.2	44.0m/8.8	42.0	
	46.0								44.0m/8.9			8.5	8.1			8.3	48.0m/7.0	46.0
	50.0												7.2			7.4	6.9	50.0
	54.0															52.0m/7.0	6.2	54.0
	58.0																56.0m/5.9	58.0
	Reeves			4				4					4			3		Reeves

33.5 m Boom Length	33.5									
	Boom length (m)	33.5								Boom length (m)
	Jib length (m)	45.7				51.8				Jib length (m)
Boom angle	88°	83°	65°	60°	88°	83°	65°	60°	Boom angle	
Working radius (m)	18.0	23.2							18.0	
	20.0	21.5						16.6	20.0	
	22.0	20.0						15.3	22.0	
	24.0	18.6	20.9					14.2	24.0	
	26.0	17.4	19.3					13.2	26.0	
	28.0	16.4	18.0					12.3	28.0	
	30.0	14.8	16.9					11.6	30.0	
	34.0	12.3	14.5					10.3	34.0	
	38.0	10.3	12.1					9.1	38.0	
	42.0	8.8	10.2					8.2	42.0	
	46.0	44.0m/8.1	8.7	7.6				6.3	46.0	
	50.0		48.0m/8.1	7.1	52.0m/5.8	4.1	6.7	52.0m/6.4	50.0	
	54.0			6.3	5.8		4.1	6.0	54.0	
	58.0			5.7	5.2			5.3	58.0	
	62.0				4.6			4.7	62.0	
	66.0							64.0m/4.5	66.0	
	70.0							68.0m/3.6	70.0	
	Reeves			2				2	Reeves	

Note: Ratings according to EN13000.  
 Ratings shown in [ ] are determined by the strength of the boom or other structural components. Refer to notes P21 and P22.

# HYDRAULIC CRAWLER CRANE CKE1800

Unit: metric ton

**Counterweight: 60.0 t, Carbody weight: 20.0 t**

39.6 m Boom Length	39.6																	Boom length (m)
	21.3				27.4				33.5				39.6				Jib length (m)	
	88°	83°	65°	60°	88°	83°	65°	60°	88°	83°	65°	60°	88°	83°	65°	60°	Boom angle	
Working radius (m)	10.0	47.4															10.0	
	12.0	47.4				47.4											12.0	
	14.0	43.4				43.0				37.7							14.0	
	16.0	38.1	39.7			37.7				37.0				29.8			16.0	
	18.0	32.2	34.2			32.1				31.9				29.3			18.0	
	20.0	27.6	29.8			27.6	29.6			27.4	29.2			27.6			20.0	
	22.0	24.0	26.4			24.1	26.2			23.9	25.9			24.0	25.5		22.0	
	24.0		23.7			21.2	23.5			21.0	23.2			21.2	23.1		24.0	
	26.0		21.4			18.9	21.2			18.7	20.9			18.8	20.9		26.0	
	28.0					17.0	19.3			16.8	19.0			16.9	19.0		28.0	
	30.0						17.7			15.2	17.4			15.3	17.4		30.0	
	34.0			12.4			32.0m/16.3			32.0m/13.8	14.8			12.7	14.7		34.0	
	38.0			11.0	10.1			10.4			12.6			10.7	12.4		38.0	
	42.0				9.1			9.4	44.0m/8.2			8.7			10.5		42.0	
	46.0								44.0m/8.8	7.7		8.0	7.1		44.0m/9.7	7.7	46.0	
	50.0											7.1	6.6			6.9	52.0m/5.9	50.0
54.0												52.0m/6.2			6.1	5.6	54.0	
58.0															56.0m/5.8	4.9	58.0	
Reeves			4				4			3				3			Reeves	

39.6		39.6				51.8				39.6						
45.7		51.8				51.8				45.7						
88°	83°	65°	60°	88°	83°	65°	60°	88°	83°	65°	60°	88°	83°	65°	60°	
Working radius (m)	18.0	23.3														18.0
	20.0	21.6					16.7									20.0
	22.0	20.1					15.4									22.0
	24.0	18.7					14.3									24.0
	26.0	17.6	19.8				13.2	15.1								26.0
	28.0	16.5	18.5				12.3	14.0								28.0
	30.0	15.0	17.1				11.6	13.1								30.0
	34.0	12.4	14.5				10.3	11.5								34.0
	38.0	10.4	12.5				9.2	10.2								38.0
	42.0	8.8	10.5				8.2	9.1								42.0
	46.0	44.0m/8.2	8.9				6.0	8.1								46.0
	50.0		48.0m/8.3	6.5			3.7	6.6	52.0m/5.6							50.0
	54.0			5.8	56.0m/4.7			3.9	5.4							54.0
	58.0			5.1	4.6				4.8	60.0m/3.8						58.0
	62.0			4.6	4.0				4.2	3.7						62.0
	66.0				64.0m/3.8				3.7	3.2						66.0
70.0								68.0m/3.5	2.8						70.0	
Reeves			2				2								Reeves	

Note: Ratings according to EN13000.  
Ratings shown in   are determined by the strength of the boom or other structural components. Refer to notes P21 and P22.

Unit: metric ton

Counterweight: 60.0 t, Carbody weight: 20.0 t

45.7 m Boom Length	45.7																Boom length (m)
	21.3				27.4				33.5				39.6				Jib length (m)
	88°	83°	65°	60°	88°	83°	65°	60°	88°	83°	65°	60°	88°	83°	65°	60°	Boom angle
Working radius (m)	10.0	47.4															10.0
	12.0	43.8			41.2												12.0
	14.0	38.3			37.5			33.0									14.0
	16.0	33.9			33.2			32.2				26.6					16.0
	18.0	30.4	33.7		29.6			28.9				26.1					18.0
	20.0	27.5	29.5		26.7	29.2		26.1	28.7			25.5					20.0
	22.0	24.3	26.1		24.3	25.8		23.7	25.6			23.1					22.0
	24.0		23.4		21.4	23.1		21.3	22.9			21.1	22.8				24.0
	26.0		21.1		19.1	20.9		19.0	20.6			19.1	20.5				26.0
	28.0				17.1	19.0		17.1	18.7			17.1	18.7				28.0
	30.0					17.4		15.4	17.2			15.4	17.1				30.0
	34.0					32.0m/16.0		12.8	14.6			12.8	14.5				34.0
	38.0			10.3			40.0m/8.9		12.6			10.7	12.5				38.0
	42.0			40.0m/9.6	8.0		8.7					11.0					42.0
	46.0				44.0m/7.8		7.7	6.6		7.4			44.0m/10.2	48.0m/6.2			46.0
	50.0							6.2		6.5	5.4			6.2			50.0
	54.0									52.0m/6.2	5.1			5.5	4.3		54.0
	58.0										56.0m/4.8			4.9	4.2		58.0
	62.0														3.7		62.0
Reeves			4				4			3				2			Reeves

45.7 m Boom Length	45.7								Boom length (m)	
	45.7				51.8				Jib length (m)	
	88°	83°	65°	60°	88°	83°	65°	60°	Boom angle	
Working radius (m)	18.0	21.4							18.0	
	20.0	21.0			16.8				20.0	
	22.0	20.2			15.5				22.0	
	24.0	18.8			14.3				24.0	
	26.0	17.6	20.3		13.3				26.0	
	28.0	16.6	18.4		12.5	14.4			28.0	
	30.0	15.1	16.8		11.7	13.4			30.0	
	34.0	12.5	14.3		10.3	11.7			34.0	
	38.0	10.5	12.3		9.2	10.4			38.0	
	42.0	8.9	10.7		8.2	9.2			42.0	
	46.0	44.0m/8.2	9.2		5.6	8.2			46.0	
	50.0		7.9	52.0m/5.0	3.3	6.5			50.0	
	54.0			5.0		3.7	56.0m/4.3		54.0	
	58.0			4.5	3.3		56.0m/2.6	4.2	58.0	
	62.0			4.0	3.3			3.6	64.0m/2.8	62.0
	66.0			64.0m/3.8	2.9			3.2	2.6	66.0
	70.0				68.0m/2.7			2.8	2.2	70.0
	74.0								72.0m/2.0	74.0
Reeves			2			2				Reeves

Note: Ratings according to EN13000.  
Ratings shown in [ ] are determined by the strength of the boom or other structural components. Refer to notes P21 and P22.

# HYDRAULIC CRAWLER CRANE CKE1800

Unit: metric ton

Counterweight: 60.0 t, Carbody weight: 20.0 t

51.8 m Boom Length	51.8																	Boom length (m)
	21.3				27.4				33.5				39.6				Jib length (m)	
	Boom angle	88°	83°	65°	60°	88°	83°	65°	60°	88°	83°	65°	60°	88°	83°	65°	60°	Boom angle
Working radius (m)	12.0	37.2				35.4												12.0
	14.0	32.7				31.6				28.8								14.0
	16.0	29.2				28.1				27.2				23.6				16.0
	18.0	26.3	31.9			25.3				24.4				23.1				18.0
	20.0	23.9	28.6			22.9	27.5			22.0				21.2				20.0
	22.0	21.8	25.7			20.9	24.9			20.1	23.5			19.3				22.0
	24.0	20.2	23.0			19.2	22.6			18.4	21.5			17.7	20.6			24.0
	26.0		20.8			17.8	20.6			16.9	19.7			16.3	19.0			26.0
	28.0		18.9			16.5	18.7			15.7	18.1			15.1	17.4			28.0
	30.0						17.1			14.6	16.7			14.0	16.0			30.0
	34.0						32.0m/15.8			12.7	14.4			12.2	13.8			34.0
	38.0			9.2							12.5			10.7	12.0			38.0
	42.0			8.3					44.0m/7.5					40.0m/10.0	10.6			42.0
	46.0			44.0m/7.8	6.5				7.1				6.1		44.0m/10.0			46.0
	50.0				48.0m/6.1				6.2	5.3			5.8	52.0m/4.1		52.0m/5.0		50.0
	54.0									52.0m/5.0			5.1	4.1		4.8		54.0
	58.0													3.8		4.3	3.2	58.0
62.0															60.0m/4.0	3.0	62.0	
66.0																64.0m/2.8	66.0	
Reeves			3					3					3			2	Reeves	

51.8 m Boom Length	51.8									Boom length (m)
	45.7				51.8				Jib length (m)	
	Boom angle	88°	83°	65°	60°	88°	83°	65°	60°	Boom angle
Working radius (m)	18.0	19.2								18.0
	20.0	18.9				15.7				20.0
	22.0	18.5				15.5				22.0
	24.0	17.0				14.4				24.0
	26.0	15.6	18.0			13.4				26.0
	28.0	14.3	16.6			12.5	14.8			28.0
	30.0	13.3	15.3			11.7	13.7			30.0
	34.0	11.5	13.1			10.4	12.0			34.0
	38.0	10.0	11.3			9.2	10.6			38.0
	42.0	8.8	9.9			8.2	9.2			42.0
	46.0	44.0m/8.3	8.8			5.3	8.1			46.0
	50.0		7.8			3.0	6.4			50.0
	54.0			3.9			3.6			54.0
	58.0			3.9			56.0m/2.4	3.3		58.0
	62.0			3.4				3.0		62.0
66.0			3.0				2.6		66.0	
70.0							2.2		70.0	
74.0							72.0m/2.0		74.0	
Reeves			2				2		Reeves	

Note: Ratings according to EN13000.

Ratings shown in  are determined by the strength of the boom or other structural components. Refer to notes P21 and P22.

Unit: metric ton

Counterweight: 60.0 t, Carbody weight: 20.0 t

54.9 m Boom Length	54.9																Boom length (m)
	21.3				27.4				33.5				39.6				Jib length (m)
	88°	83°	65°	60°	88°	83°	65°	60°	88°	83°	65°	60°	88°	83°	65°	60°	Boom angle
Working radius (m)	12.0	33.7			32.6												12.0
	14.0	29.8			28.8				26.9								14.0
	16.0	26.7			25.6				24.7				22.2				16.0
	18.0	24.1	29.6		23.1				22.1				21.2				18.0
	20.0	21.9	26.5		21.0	24.9			20.0				19.2				20.0
	22.0	20.2	24.0		19.2	22.7			18.2	21.5			17.5				22.0
	24.0	18.7	21.9		17.6	20.6			16.7	19.7			16.0				24.0
	26.0		20.1		16.3	18.9			15.4	18.0			14.7	17.3			26.0
	28.0		18.6		15.2	17.5			14.3	16.6			13.6	15.8			28.0
	30.0				14.2	16.2			13.3	15.3			12.6	14.6			30.0
	34.0					32.0m/15.1			11.6	13.2			11.0	12.5			34.0
	38.0			40.0m/8.1						11.6			9.7	10.9			38.0
	42.0			8.0									40.0m/9.1	9.6			42.0
	46.0			44.0m/7.5			6.6					48.0m/5.3		44.0m/9.1			46.0
	50.0						5.9						5.3			52.0m/4.2	50.0
	54.0												4.8			4.2	54.0
	58.0												56.0m/4.5			3.9	58.0
	62.0															3.4	62.0
	Reeves			3			3					3				2	Reeves

54.9 m Boom Length	54.9								Boom length (m)
	45.7				51.8				Jib length (m)
	88°	83°	65°	60°	88°	83°	65°	60°	Boom angle
Working radius (m)	18.0	18.2							18.0
	20.0	17.9			14.9				20.0
	22.0	16.7			14.6				22.0
	24.0	15.2			14.3				24.0
	26.0	14.0	16.2		13.2				26.0
	28.0	12.9	15.0		12.1	14.0			28.0
	30.0	11.9	13.8		11.2	13.0			30.0
	34.0	10.3	11.8		9.6	11.0			34.0
	38.0	9.0	10.2		8.3	9.4			38.0
	42.0	7.9	8.9		7.2	8.2			42.0
	46.0	44.0m/7.4	7.8		5.2	7.1			46.0
	50.0		7.0		2.8	6.3			50.0
	54.0			56.0m/3.2		3.5			54.0
	58.0			3.2		56.0m/2.3	60.0m/2.9		58.0
	62.0			3.1			2.7		62.0
	66.0			2.7			2.3		66.0
	70.0			68.0m/2.5					70.0
	Reeves			2			2		Reeves

Note: Ratings according to EN13000.  
Ratings shown in [ ] are determined by the strength of the boom or other structural components. Refer to notes P21 and P22.



# HYDRAULIC CRAWLER CRANE CKE1800

## Luffing Boom Lifting Capacities with Luffing Jib Attached at 23 Degree Boom to Luffing Jib Offset Angle

Unit: metric ton

Counterweight: 60.0 t,  
Carbody weight: 20.0 t

21.3 m Boom Length	Boom length (m)	21.3					
	Jib length (m)	21.3	27.4	33.5	39.6	45.7	51.8
	7.0	70.6	67.8	65.0	61.5	57.9	53.6
	8.0	70.6	67.8	65.0	61.5	57.9	53.6
	9.0	70.6	67.8	65.0	61.5	57.9	53.6
	10.0	66.0	63.7	61.4	58.5	55.7	52.3
	12.0	48.7	46.6	44.5	41.8	39.2	36.1
	14.0	37.8	35.8	33.8	31.3	28.9	25.9
	16.0	30.3	28.4	26.5	24.1	21.8	19.0
	18.0	24.7	22.8	21.0	18.7	16.6	13.9
	20.0	20.3	18.5	16.8	14.7	12.6	10.0
	21.0	18.5	16.7	15.1	12.9	10.9	8.4
	Reeves	6	6	5	5	5	5

27.4 m Boom Length	Boom length (m)	27.4					
	Jib length (m)	21.3	27.4	33.5	39.6	45.7	51.8
	8.0	71.1	68.6	66.1	62.9	59.8	56.0
	9.0	71.1	68.6	66.1	62.9	59.8	56.0
	10.0	66.2	64.1	62.0	59.3	56.7	53.5
	12.0	48.9	47.0	45.0	42.6	40.2	37.3
	14.0	38.0	36.2	34.4	32.1	29.8	27.1
	16.0	30.5	28.7	27.0	24.8	22.7	20.2
	18.0	24.9	23.2	21.5	19.4	17.4	15.0
	20.0	20.5	18.9	17.3	15.3	13.4	11.0
	22.0	17.2	15.6	14.0	12.1	10.3	8.0
	24.0	14.4	12.9	11.4	9.5	7.7	5.5
	25.0	13.2	11.7	10.2	8.4	6.7	4.5
	Reeves	6	6	5	5	5	5

33.5 m Boom Length	Boom length (m)	33.5					
	Jib length (m)	21.3	27.4	33.5	39.6	45.7	51.8
	9.0	71.5	69.3	67.2	64.4	61.7	58.4
	10.0	64.9	62.9	60.9	58.4	55.9	52.9
	12.0	49.0	47.1	45.3	43.0	40.8	38.0
	14.0	38.0	36.2	34.5	32.4	30.3	27.8
	16.0	30.4	28.7	27.1	25.0	23.1	20.7
	18.0	24.7	23.1	21.6	19.6	17.8	15.5
	20.0	20.5	18.9	17.4	15.5	13.8	11.6
	22.0	17.0	15.5	14.1	12.2	10.5	8.4
	24.0	14.2	12.8	11.4	9.6	7.9	5.9
	26.0	12.0	10.5	9.2	7.5	5.8	
	28.0	10.1	8.7	7.4	5.7	4.1	
	30.0	8.5	7.2	5.9	4.2		
	32.0	7.2	5.8	4.6			
	Reeves	6	6	6	5	5	5

39.6 m Boom Length	Boom length (m)	39.6					
	Jib length (m)	21.3	27.4	33.5	39.6	45.7	51.8
	10.0	61.4	59.5	57.5	55.1	52.8	49.9
	12.0	48.7	46.9	45.1	42.9	40.8	38.2
	14.0	37.9	36.2	34.6	32.5	30.5	28.1
	16.0	30.2	28.6	27.1	25.2	23.3	21.0
	18.0	24.6	23.1	21.6	19.7	18.0	15.8
	20.0	20.2	18.8	17.3	15.6	13.9	11.8
	22.0	16.8	15.3	14.0	12.2	10.6	8.6
	24.0	14.0	12.6	11.3	9.6	8.0	6.1
	26.0	11.8	10.4	9.1	7.4	5.9	4.0
	28.0	9.9	8.5	7.3	5.7	4.2	
	30.0	8.3	7.0	5.7	4.2		
	32.0	6.9	5.6	4.4			
	35.0	5.2	3.9				
	36.0	4.7					
	37.0	4.2					
	Reeves	5	5	5	5	4	4

45.7 m Boom Length	Boom length (m)	45.7					
	Jib length (m)	21.3	27.4	33.5	39.6	45.7	51.8
	11.0	51.9	50.1	48.3	46.1	43.9	41.3
	12.0	46.6	44.8	43.2	41.0	39.0	36.4
	14.0	37.7	36.1	34.5	32.5	30.6	28.3
	16.0	30.1	28.5	27.0	25.2	23.4	21.2
	18.0	24.4	22.9	21.5	19.7	18.0	16.0
	20.0	20.1	18.6	17.3	15.6	13.9	11.9
	22.0	16.6	15.2	13.9	12.2	10.7	8.8
	24.0	13.8	12.5	11.2	9.6	8.1	6.2
	26.0	11.6	10.2	9.0	7.4	6.0	4.1
	28.0	9.7	8.4	7.2	5.6	4.2	
	30.0	8.0	6.7	5.5	4.0		
	32.0	6.6	5.4	4.2			
	34.0	5.4	4.2				
	36.0	4.4					
	37.0	3.9					
	Reeves	4	4	4	4	4	4

51.8 m Boom Length	Boom length (m)	51.8					
	Jib length (m)	21.3	27.4	33.5	39.6	45.7	51.8
	12.0	44.5	42.8	41.1	39.0	37.0	34.6
	14.0	36.4	34.8	33.3	31.3	29.5	27.2
	16.0	29.7	28.2	26.8	25.0	23.3	21.1
	18.0	24.1	22.7	21.3	19.6	17.9	15.9
	20.0	19.7	18.3	17.0	15.4	13.8	11.9
	22.0	16.3	14.9	13.7	12.1	10.6	8.7
	24.0	13.5	12.2	11.0	9.4	8.0	6.2
	26.0	11.2	10.0	8.8	7.2	5.8	4.1
	28.0	9.4	8.1	6.9	5.4	4.1	
	30.0	7.7	6.4	5.3	3.8		
	32.0	6.3	5.1	4.0			
	34.0	5.1	3.9				
	36.0	4.0					
	Reeves	4	4	4	3	3	3

54.9 m Boom Length	Boom length (m)	54.9					
	Jib length (m)	21.3	27.4	33.5	39.6	45.7	51.8
	13.0	39.3	37.7	36.2	34.2	32.3	30.0
	14.0	35.6	34.0	32.5	30.6	28.8	26.6
	16.0	29.4	27.9	26.5	24.7	23.0	20.9
	18.0	23.9	22.5	21.2	19.5	17.8	15.9
	20.0	19.6	18.2	16.9	15.3	13.7	11.8
	22.0	16.1	14.8	13.5	12.0	10.5	8.6
	24.0	13.3	12.0	10.8	9.3	7.9	6.1
	26.0	11.1	9.8	8.6	7.1	5.7	4.0
	28.0	9.1	7.9	6.7	5.2	3.9	
	30.0	7.5	6.3	5.2	3.7		
	32.0	6.1	4.9	3.8			
	34.0	4.9	3.7				
	35.0	4.3					
	Reeves	3	3	3	3	3	3

Note: Ratings according to EN13000.

Ratings shown in   are determined by the strength of the boom or other structural components.

Refer to notes P21 and P22.

# PARTS AND ATTACHMENTS

## Base Machine

Including 3rd winch, Translifter, Low boom, Main wire, Boom wire  
Weight: 43,820 kg

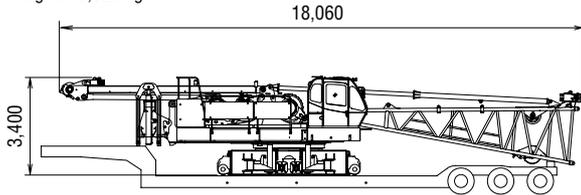

## Base Machine

Including 3rd winch, Translifter, Main wire, Boom wire  
Weight: 39,300 kg

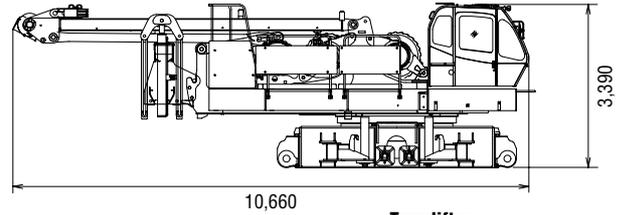

## Crawler

Weight: 18,000 kg

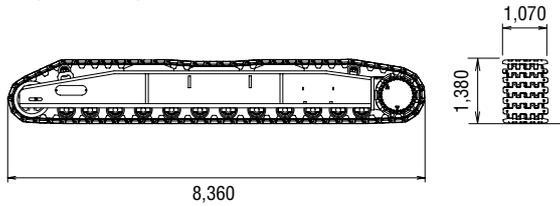

## Gantry

Weight: 2,950 kg

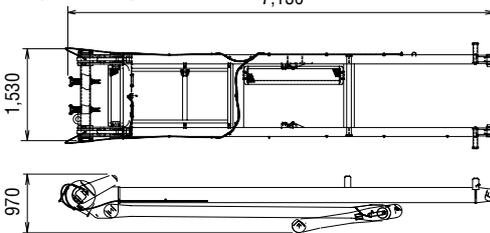

## Translifter

Weight: 360 kg

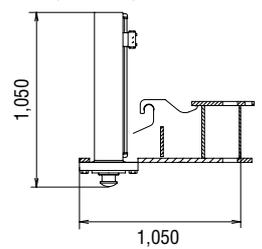

## Counterweight A

Weight: 10,000 kg

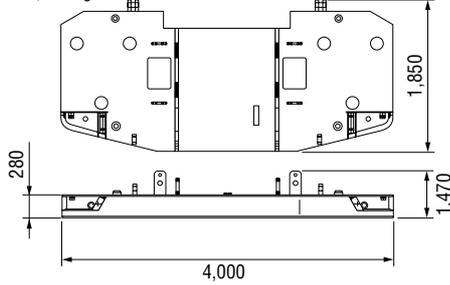

## Counterweight B

Weight: 5,000 kg x 10 pieces

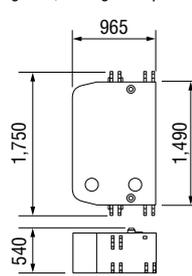

## Carbody Weight A

Weight: 5,000 kg x 2 pieces

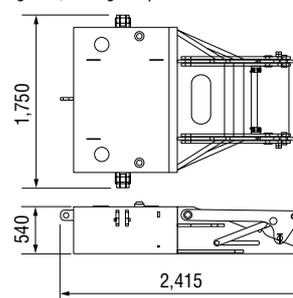

## Carbody Weight B

Weight: 5,000 kg x 2 pieces

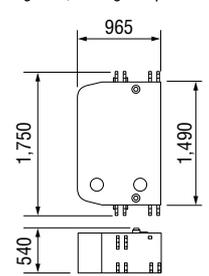

## Boom Base

Weight: 2,620 kg

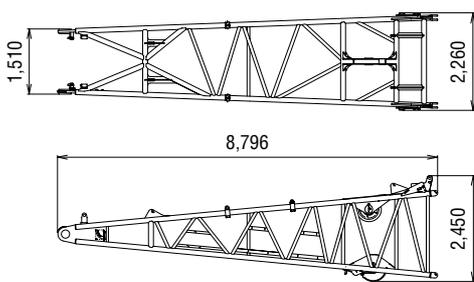

## Taper Insert Boom

Weight: 710 kg

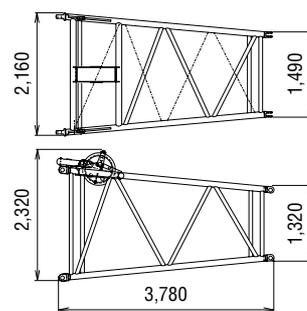

## Boom Tip

Weight: 2,100 kg

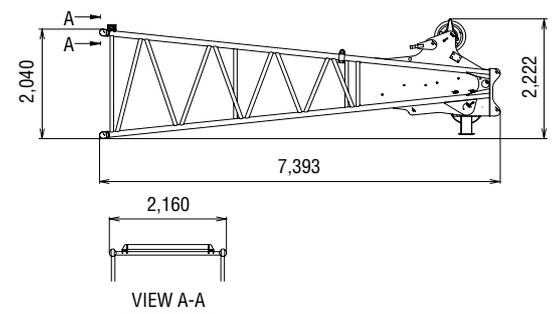

## Heavy Boom Tip

Weight: 2,580 kg

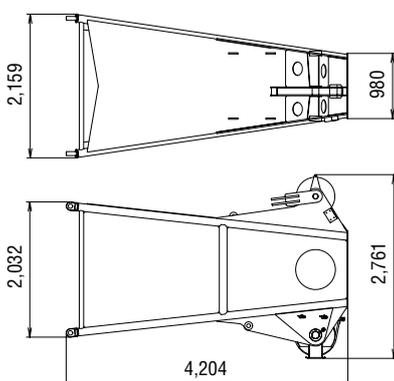

## 3.0 m Insert Boom

Weight: 530 kg

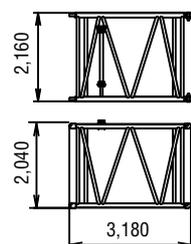

## 6.1 m Insert Boom

Weight: 880 kg

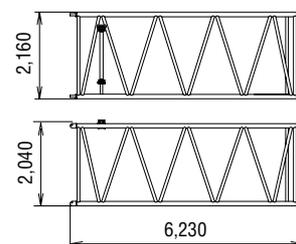

## 9.1 m Insert Boom

Weight: 1,220 kg

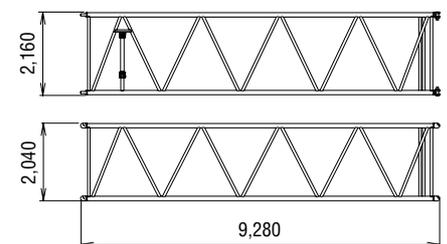

# HYDRAULIC CRAWLER CRANE CKE1800

Dimensions: mm Weight: kg

## 12.2 m Insert Boom

Weight: 1,450 kg

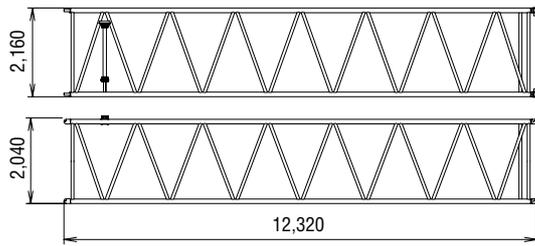

## Boom Backstop

Weight: 740 kg / 1 piece

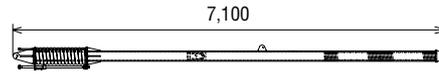

## Jib Base (for Crane)

Weight: 210 kg

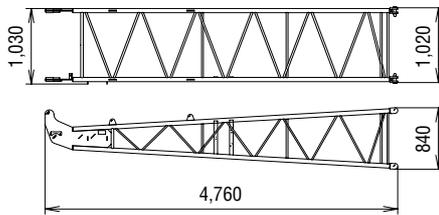

## Jib Tip (for Crane)

Weight: 315 kg

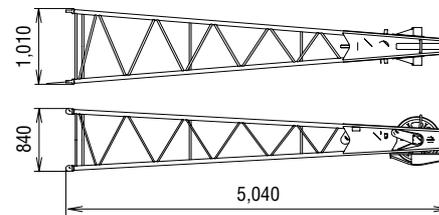

## Jib Strut

Weight: 300 kg

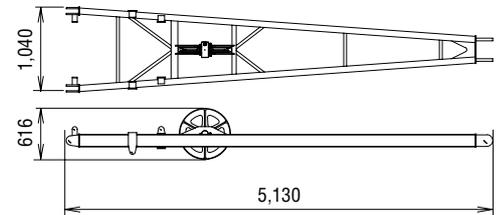

## 3.0 m (Insert Jib)

Weight: 110 kg

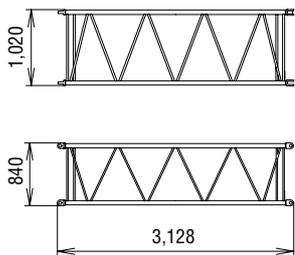

## 6.1 m (Insert Jib)

Weight: 190 kg

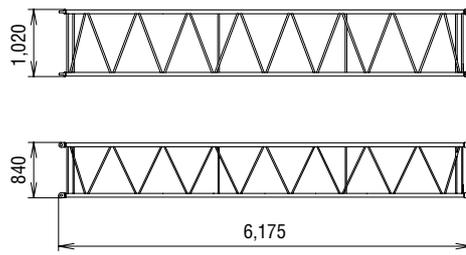

## 3.0 m Insert Jib

Weight: 310 kg

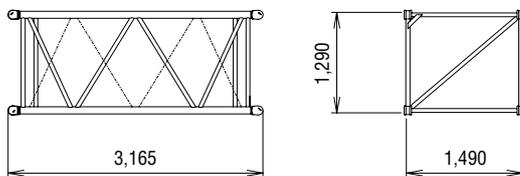

## 6.1 m Insert Jib

Weight: 540 kg

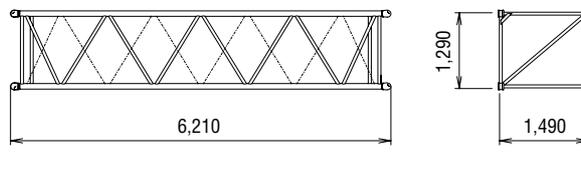

## 9.1 m Insert Jib (Long Insert Boom)

Weight: 740 kg

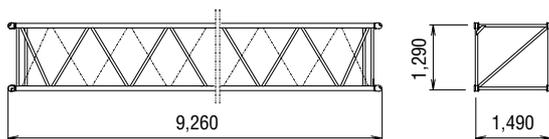

## 12.2 m Insert Jib

Weight: 960 kg

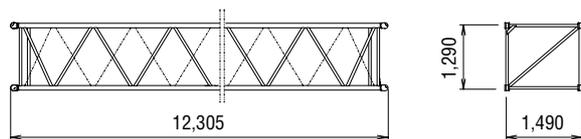

# PARTS AND ATTACHMENTS

## Luffing Upper Boom

Weight: 2,545 kg

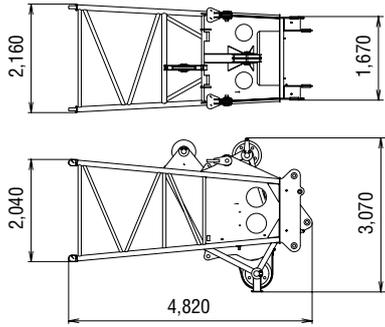

## Luffing Jib Base

Weight: 1,140 kg

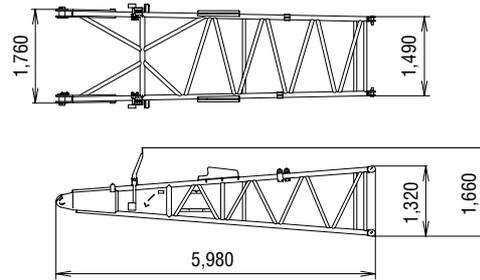

## Luffing Jib Tip

Weight: 1,170 kg

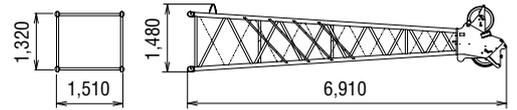

## Luffing Jib Backstop

Weight: 100 kg / 1 piece

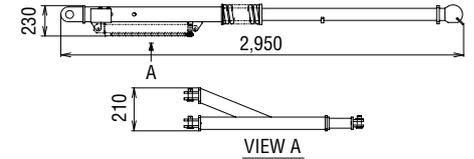

## Front Strut (Luffing Jib)

Weight: 1,000 kg

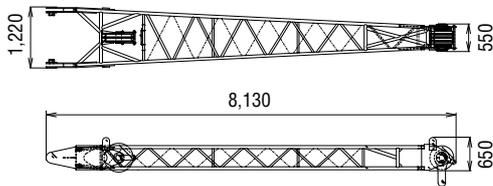

## Rear Strut (Luffing Jib)

Weight: 1,090 kg

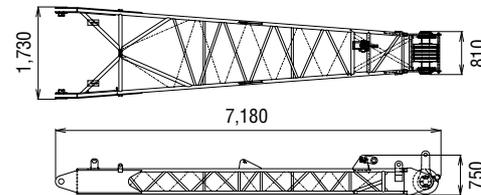

## Strut Backstop (Luffing Jib)

Weight: 180 kg / 1 piece

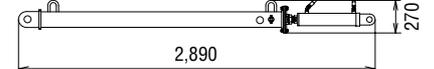

## Aux. Sheave

Weight: 300 kg

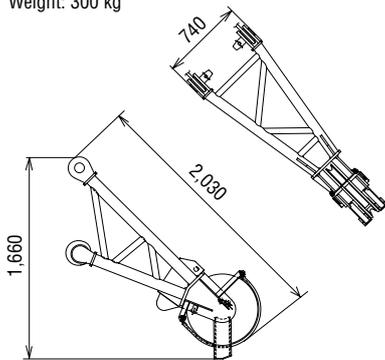

## Aux. Sheave (for Luffing Jib)

Weight: 380 kg

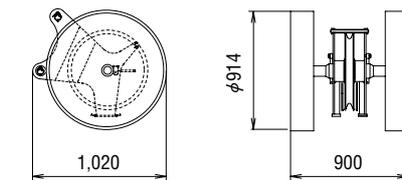

## Upper Spreader

Weight: 590 kg

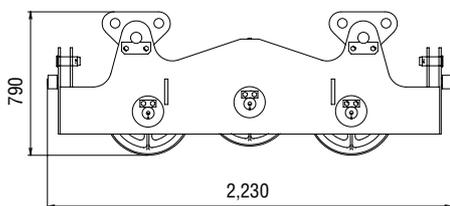

## Lower Spreader

Weight: 400 kg

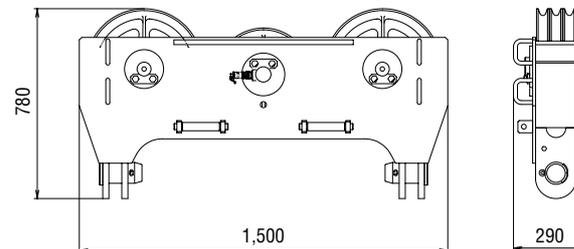

# HYDRAULIC CRAWLER CRANE CKE1800

## Luffing Boom Tip Assembly

Weight: 6,600 kg

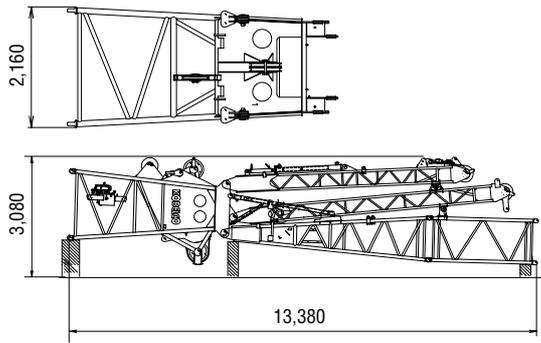

## Luffing Jib Drum

Weight: 1,470 kg

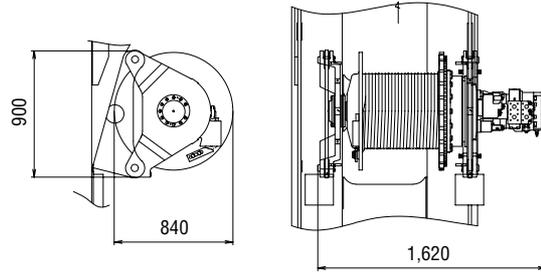

## Ball Hook

Weight: 460 kg

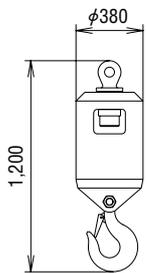

## 35 t Hook Block

Weight: 900 kg

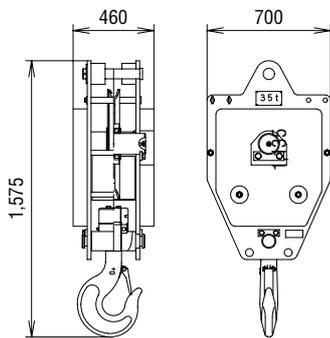

## 70 t Hook Block

Weight: 1,200 kg

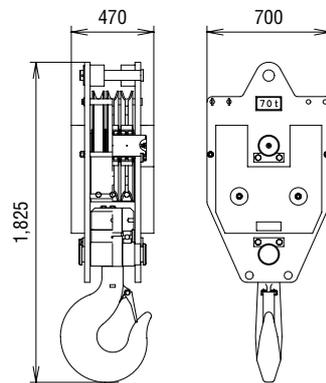

## 110 t Hook Block

Weight: 1,730 kg

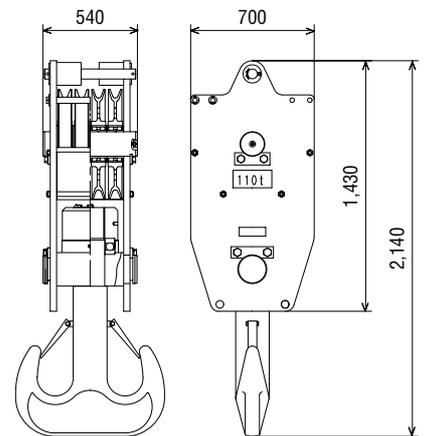

## 160 t Hook Block

Weight: 2,800 kg

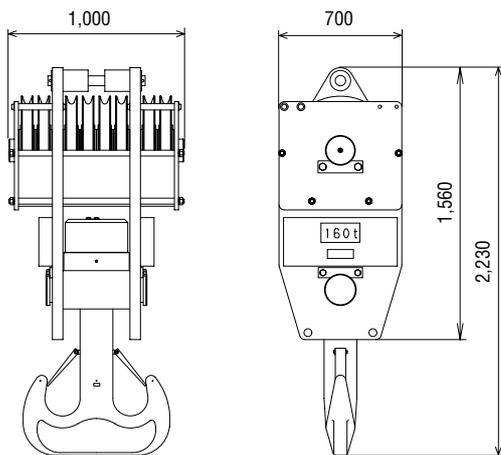

## 180 t Hook Block

Weight: 2,800 kg

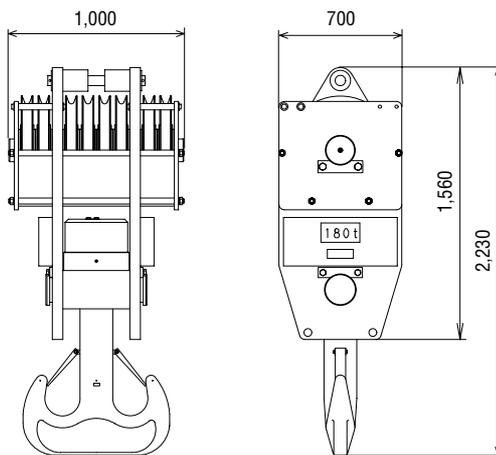

# TRANSPORTATION PLAN

## Luffing Boom 54.9 m + Luffing Jib 51.8 m

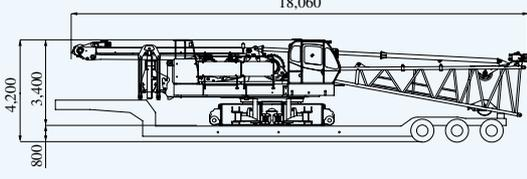
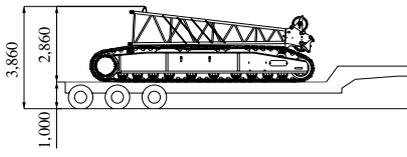
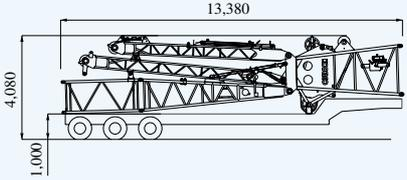
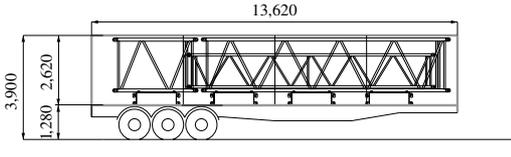
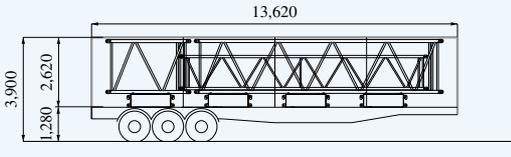
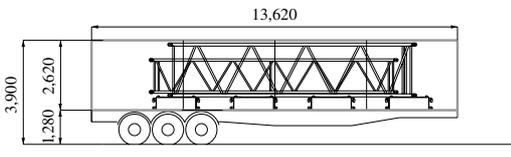
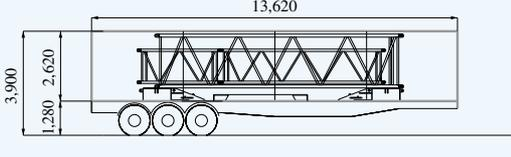
Configuration	Description	Total Weight
<b>No.1 Low Loader</b> <span style="float: right;">Width: 3,500 mm</span> 	Base Machine = Including 3rd winch Translifter Low Boom Main Wire Boom Wire	43.82 t
<b>No.2 Semi Loader</b> 	Crawler No.1 = Crawler No.2 = Luffing Jib Top = Total =	18.00 t 18.00 t 1.17 t 37.17 t
<b>No.3 Semi Loader</b> 	Luffing boom tip assembly	6.60 t
<b>No. 4 Tent Side Truck</b> 	Counterweight No.2 (4 x 5.00 ton) = 9.1 m Insert Boom x 1 = 9.1 m Luffing Insert Jib x 1 = 3.0 m Insert Boom x 1 = Total =	20.00 t 1.22 t 0.74 t 0.63 t 22.59 t
<b>No.5 Tent Side Truck</b> 	Counterweight No.2 (4 x 5.00 ton) = 9.1 m Insert Boom x 1 = 9.1 m Luffing Insert Jib x 1 = 3.0 m Insert Boom x 1 = Total =	20.00 t 1.42 t 0.74 t 0.53 t 22.69 t
<b>No.6 Tent Side Truck</b> 	Counterweight No.2 (2 x 5.00 ton) Carbody Weight No.2 (2 x 5.00 ton) = 9.1 m Insert Boom x 1 = 9.1 m Luffing Insert Jib x 1 = Total =	10.00 t 10.00 t 1.42 t 0.74 t 22.16 t
<b>No.7 Tent Side Truck</b> 	Counterweight No.1 Base = 9.1 m Insert Boom x 1 = 6.1 m Luffing Insert Jib x 1 = 3.0 m Luffing Insert Jib x 1 = Carbody Weight No.1 (2 x 5.07 ton) = Total =	10.00 t 1.22 t 0.54 t 0.31 t 10.14 t 22.21 t

Note: Estimated weights may vary  $\pm$  2%.

This transport plan depends on specifications of your trailers/trucks and the areas or countries where you transport.







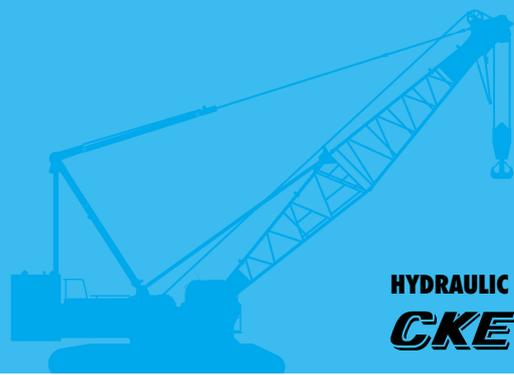

**HYDRAULIC CRAWLER CRANE**  
***CKE1800***

**Standard Equipment**

**Upper structure/Lower structure**

Counterweight: 60.0 ton (total weight)  
 Carbody weight: 20.0 ton (total weight)  
 1,070 mm shoe crawlers  
 Batteries (170 Ah/20 HR)  
 Trans-lifter (jack system)  
 Gantry raising/lowering cylinder  
 Electric hand throttle grip  
 Variable boom hoist speed controller  
 Swing neutral-free/brake select switch  
 Side deck for cab  
 Side deck (right side guard)  
 Steps (crawlers)  
 Two front working lights  
 Tools (for routine maintenance)  
 Two rear view mirrors  
 Electric fuel pump  
 Counterweight self removal  
 Crawler self removal  
 Cable roller (for boom)

**Cab/Control**

Boom hoist pedal  
 Air conditioner  
 Cup holder  
 Ashtray  
 Cigar lighter  
 Intermittent wiper & window washer (skylight and front window)  
 Sun visor  
 Roof blind  
 Floor mat (cloth)  
 Foot rest  
 Shoe tray  
 Level gauge (operator cabin)

**Safety Device**

Load Moment Indicator (with boom lowering slow stop function)  
 LMI release key (for hook over-hoist prevention device and boom over-hoist prevention device)  
 LCD multi display  
 Ultimate stop function for boom over-hoist  
 Function lock lever  
 Propel lever lock  
 Mechanical drum lock pawl (main, aux. and boom hoist)  
 Signal horn  
 Swing parking brake  
 Mechanical swing lock pin (four positions)  
 Swing flashers/warning buzzer  
 Cab window guard (left side)  
 Cab top guard  
 Fire extinguisher  
 External lamp for over-load alarm  
 Life hammer

**Note:** Standard equipment may vary depending on your areas or countries.

Due to our policy of continual product improvements all designs and specifications are subject to change without advance notice.

Copyright by KOBELCO CONSTRUCTION MACHINERY CO., LTD. No part of this catalog may be reproduced in any manner without notice.

**KOBELCO CONSTRUCTION MACHINERY CO., LTD.**

5-15, Kitashinagawa 5-chome, Shinagawa-ku, Tokyo 141-8626 JAPAN

Tel: +81-3-5789-2121 Fax: +81-3-5789-3372

URL: <https://www.kobelcocm-global.com>

Inquiries To:

**KOBELCO** is the corporate mark used by Kobe Steel on a variety of products and in the names of a number of Kobe Steel Group companies.